



evoqua
WATER TECHNOLOGIES

BLU-SENTINEL™ PRO ELECTRONICS MODULE Version 1.31 and later

INSTRUCTION MANUAL



Please note

Original instruction manual!

Contents

1.	Introduction	5
1.1	Documentation	5
1.2	Conventions	6
2.	Safety	9
2.1	Intended use	9
2.2	General safety instructions	9
2.3	Specific operating phases	11
2.4	Warranty conditions	12
2.5	Warranty	12
2.6	Disclaimer	14
3.	Description	15
3.1	General	15
3.2	Version	16
3.3	Design	17
3.4	Functions	18
3.5	Technical Data electronics module (module type E01)	44
4.	Interfaces	47
4.1	CAN interface	47
4.2	RS485 interface	49
4.3	USB interface	50
4.4	Fieldbus connection	50
4.5	Ethernet interface	50
4.6	Modbus TCP interface	52

5.	Installation	59
5.1	Scope of supply	59
5.2	Transport and storage	60
5.3	Requirements for the ambient conditions	60
5.4	Mechanical installation	61
5.5	Electrical installation	65
5.6	Commissioning	71
5.7	Shutting down	74
5.8	Renewed start up	74
6.	Operation	75
6.1	Display and control elements	75
6.2	Menus	78
6.3	Calibration	123
6.4	Errors and remedies	131
7.	Maintenance	137
7.1	Maintenance intervals	137
7.2	Changing the fuses on the A&C board	138
7.3	Replacing the battery	139
7.4	Cleaning	140
8.	Retrofit kits and spare parts	141
8.1	Retrofit kits	141
8.2	Installing retrofit kits	142
8.3	Spare parts	143
9.	Wiring Diagrams	149
10.	Declarations and certificates	153
10.1	Declaration of Conformity	153
10.2	Certificate of Compliance	155
11.	Index	159

1. Introduction

1.1 Documentation

1.1.1 Target groups

This instruction manual provides information to the installation, operating and maintenance personnel required for the operation and maintenance of the Blu-Sentinel™ Pro electronics module (module type E01).

All persons working with the Blu-Sentinel™ Pro electronics module must have read and understood the instruction manual, in particular, the safety instructions it contains.

1.1.2 Documentation Structure

This instruction manual is intended for operators of the Blu-Sentinel™ Pro electronics module. It contains important information for safe, trouble-free, and efficient operation of the Blu-Sentinel™ Pro electronics module. Observing these instructions will help prevent risks, reduce repair costs and downtimes, and increases the reliability and service life of the Blu-Sentinel™ Pro electronics module.











Chapters Installation, Commissioning, and Maintenance are intended only for trained and authorized service personnel. These chapters contain important information on the assembly, configuration, commissioning and start-up, maintenance and repair of the Blu-Sentinel™ Pro electronics module that should only be performed by this target group.







Please consult the table of contents and the index to quickly find the information you require.

1.2 Conventions

NOTICE

This instruction manual contains a number of safety notes with different priorities, which are marked with safety panels and pictograms.

Pictogram	Safety Panel	Safety note
		Immediate danger to life and limb! If the situation is not handled properly, death or serious injury is the result.
		Danger to life and limb! If the situation is not handled properly, death or serious injury may be the result.
		If this warning is not observed, there is a medium or slight risk that injury or damage to the equipment may be the result.
		Electrical hazard.
		Never override sample flow switch! Uncontrolled feeding of chemicals can result in injury or death. Sample flow switch is a critical safety device which prevents uncontrolled chemical feed. Follow instructions carefully!
		Test flow switch function! Uncontrolled feeding of chemicals can result in injury or death. Assure flow switch prevents chemical feed in any circulation NO-FLOW or backwash condition. Follow instructions carefully!
		Always use anti-siphon devices! Uncontrolled feeding of chemicals can result in injury or death. Anti-siphon devices must be installed to prevent uncontrolled chemical feed. Follow instructions carefully.

Pictogram	Safety Panel	Safety note
		<p>Never connect feeder directly to power source! Uncontrolled feeding of chemicals can result in injury or death. Chemical metering pumps must be connected to the controller to enable safety controls. Follow instructions carefully.</p>
		<p>Always install interlock! Chemical feed without water circulation can result in injury or death. Circulation pump interlock with chemical feeders is a critical safety device which prevents unsafe chemical feed. Recirculation pump must be interlocked to prevent chemical feed whenever pump power is removed. Follow instructions carefully.</p>
		<p>Electrical surges can damage your controller! A damaged controller could feed chemicals in an uncontrolled manor. Uncontrolled feeding of chemicals can result in injury or death. If you suspect your controller is not operating properly, disconnect it from control of chemical feed</p>
		<p>These notes assist in the operation of the system.</p>

2. Safety

2.1 Intended use

The Blu-Sentinel™ Pro electronics module (module type E01) in conjunction with the Blu-Sentinel™ Pro flow cell (module type D01) and the integrated sensors is designed for measuring and controlling tasks during the treatment of swimming and spas.

The operational safety of the Blu-Sentinel™ Pro electronics module is only guaranteed if it is used in accordance with its intended application. It may only be used for the purpose defined in the order and under the installation, operating and ambient conditions specified in this instruction manual.

All inspection and maintenance work must be carried out in accordance at the specified intervals.

Compliance with the intended use also includes reading this instruction manual and observing all the instructions it contains.

The operator bears full and sole responsibility if this unit is put to any use which does not comply strictly and exclusively with this intended use.

⚠ DANGER**Risk of injury or death!**

The device must not be used with flammable liquids.

2.2 General safety instructions

The manufacturer places great value upon safety when working with the unit. This was already taken into account in the design of the system, by the integration of safety features.

Safety regulations

The safety instructions in this documentation must be observed. Additional industry-wide or in-house safety regulations also continue to apply.

Safety warnings on the unit

All safety instructions attached to the unit itself must be observed. These instructions must always be clearly legible and complete.

<i>State-of-the-art technology</i>	The unit has been manufactured in accordance with state-of-the-art technology and the accepted safety regulations. However, if the unit is used by persons who have not been adequately trained, risks to life and limb of such persons or third parties and damage to the unit itself or to other property cannot be ruled out. Work described in this instruction manual must be performed only by authorized personnel.
<i>Personnel</i>	The operator of the overall system must ensure that only authorized and qualified specialized personnel are permitted to work with and on the unit within their defined scope of authority. "Authorized, specialized personnel" refers to trained technicians employed by the operator, the manufacturer, or, if applicable, the service partner. Only qualified electricians must perform work on electrical components.
<i>Spare parts / components</i>	Trouble-free operation of the unit is only guaranteed if original spare parts and components are used in precisely the combination described in this instruction manual. Failure to observe this instruction may incur the risk of malfunction or damage to the unit.
<i>Extensions and conversions</i>	Never attempt to perform any modifications, extensions or conversions on the unit that could have an adverse affect on safety without the written approval of the manufacturer.
<i>Electrical power</i>	Only qualified electricians or trained personnel supervised by a qualified electrician are permitted to perform any work on electrical components in accordance with valid electro-technical regulations. During normal operation, the electronics enclosure must remain closed. Connect the power cables in accordance with the wiring diagram.

▲ DANGER

Risk of injury or death!

External voltages may be connected even with the operating voltage switched off. Disconnect all power sources before opening the Blu-Sentinel™ Pro electronics module. In the event of a fault in the electrical power supply, switch the Blu-Sentinel™ Pro electronics module off immediately.

IT security The manufacturer offers IT security mechanisms for its products to support secure system operation. We recommend checking on a regular basis to see what information is available regarding IT security developments for your products. Information on this can be found on the Internet.

For the safe operation of an installation, it is furthermore necessary to integrate the automation components into a holistic IT security concept which comprises the entire system and is in accordance with latest state of the art technology. In the process, implemented products deriving from other manufacturers should be taken into account.

Upon start-up of the Blu-Sentinel™ Pro electronics module, it should be ensured that the factory-configured passwords and user names are replaced with individual ones.

Disposal

Ensure safe and environment-friendly disposal of agents as well as replacement parts.



Attention!

Environmental hazard!

Dispose of the electronics waste in accordance with valid local and national regulations.

2.3 Specific operating phases

Normal operation

Never employ any working methods which could affect safety!

The device must not be used with flammable liquids.

Only run the Blu-Sentinel™ Pro electronics module when the housing is closed!

Inspect the Blu-Sentinel™ Pro electronics module at least once daily for externally visible damage and faults! Inform the responsible person/authority immediately of any detected changes (including any changes in the operating performance)!

In the event of malfunctions, switch the Blu-Sentinel™ Pro electronics module off immediately! Have malfunctions remedied immediately!

Installation and maintenance work

Secure the Blu-Sentinel™ Pro electronics module against activation during installation and maintenance work!

If stipulated, disconnect all parts of the Blu-Sentinel™ Pro electronics module from the power supply before performing any inspection, maintenance or repair work. Then first test the disconnected components to ensure they do not carry any voltage.

Inspect/check the Blu-Sentinel™ Pro electronics module of the system regularly. Remedy any faults immediately.

Do not use aggressive cleaning agents (e.g., alcohol, abrasive cleaners)! We recommend a damp cloth moistened with a commercially available neutral detergent.

2.4 Warranty conditions

The following must be observed for compliance with warranty conditions:

- Installation and commissioning by Evoqua Water Technologies personnel or trained and authorized specialized personnel, e.g. of contracted companies
- Intended use
- Observation of the operational parameters and settings.
- The unit may only be operated by trained personnel.
- An operating log book must be kept (only in the public sector).
- Only approved calibration chemicals may be used
- The unit must not be exposed to frost.
- Maintenance work must be executed
- Use of genuine spare parts

If any of the above conditions are not met, the warranty is void.

2.5 Warranty

Evoqua Water Technology warrants equipment of its manufacture and bearing its trademark to be free of defects in materials and workmanship and to materially conform to any applicable specifications and drawings approved in writing by Evoqua Water Technologies.

If the customer gives Evoqua Water Technologies prompt written notice of breach of this warranty within twelve months from the date of start-up for the controller in accordance with the below conditions (the "Warranty Period"), Evoqua Water Technologies will, at its sole option and as the customer's exclusive remedy, either repair or replace free of charge, or refund the purchase price paid with respect to, any material found to be defective during the warranty period.

No repair or replacement of defective products shall extend the warranty period, but any such repaired or replaced product shall be covered for the balance of the original warranty period. If Evoqua Water Technologies determines that any claimed breach is not, in fact, covered by this warranty, the customer shall pay Evoqua Water Technologies 's then customary charges for any repair or replacement.

The "Warranty Period" for Blu-Sentinel controller components shall be as follows: a) the controller electronics shall be five (5) years from the date of manufacture b) the Strantrol sensors shall be two (2) years from the date of shipment c) the Wallace & Tiernan sensors (if used) and flow cell shall be one (1) year from the date of shipment.

The foregoing warranty is subject to the following conditions: (i) initial start-up of the equipment shall be completed by a factory authorized representative within the first twelve months after shipment of the equipment, with such installation and start-up to be documented in a duly completed start-up and field test report to be returned to Evoqua Water Technologies by the customer within thirty (30) days of start-up.; (ii) the customer shall have operated and maintained the equipment in accordance with all instructions provided by Evoqua Water Technologies; (iii) the customer shall not have made any unauthorized repairs or alterations; (iv) the customer shall not be in default of any payment obligation to Evoqua Water Technologies; (v) if requested, the customer will deliver the equipment to Evoqua Water Technologies authorized service center the customer shall pay all inbound and outbound freight costs; (vi) the customer must provide a complete and detailed description of the problem including, without limitation the Evoqua Water Technologies job number, date of delivery, date of installation, date of start-up and the operating conditions of the unit (s); and (vii) for equipment which is destined for extended storage, such equipment must have been stored in the accordance with the storage requirements detailed in the operation and maintenance manual (storage of equipment does not extend the warranty period).

The foregoing warranty does not extend to, and Evoqua Water Technologies assumes no responsibility for, (i) the installation quality or any services defects resulting there from unless a Evoqua Water Technologies representative or designee supervised the installation; (ii) in the event that the unit size and location are predetermined by someone other than by Evoqua Water Technologies or our local representative, the serviceability and/or performance of the unit for the specified design and/or actual operating conditions (this exclusion shall not apply if all necessary design information is submitted to and approved in writing by Evoqua Water Technologies); (iii) any auxiliary equipment or accessories supplied by Evoqua Water Technologies but manufactured by others (the original manufacturer's warranty, if any, shall apply to such products); (iv) damage to the equipment or products resulting from normal wear, abuse, neglect or operation in a manner inconsistent with Evoqua Water Technologies' recommendations; and (v) damage to the equipment or products that have been modified, tampered with or altered without written consent from Evoqua Water Technologies.

In addition to the foregoing conditions and limitations, the following product-specific limitations and conditions must be satisfied for the foregoing warranty to apply:

- This warranty does not cover damage caused by chemical action or abrasive material, damage caused by handling or during transportation, or damage arising from misuse, installation or any other cause beyond Evoqua Water Technologies' control.
- Standard units not in outdoor configurations are not warranted in outdoor applications.

The warranties set forth above are Evoqua Water Technologies' sole and exclusive warranties. Evoqua Water Technologies makes no other warranties of any kind, express or implied, including without limitation, any warranty of merchantability or of fitness for a particular purpose, all warranties arising from course and dealing and usage of trade and all such express or implied warranties are hereby disclaimed. The remedies provided above are the customer's sole remedies for Evoqua Water Technologies' failure to comply with obligations. Correction of any nonconformity in the manner and for the period of the time provided above shall constitute complete fulfillment of all the warranty liabilities of Evoqua Water Technologies, whether the claims of the purchaser are based in contract, in tort (including negligence) or otherwise with respect to or arising out of the work performed hereunder.

Limitation of liability: notwithstanding anything else to the contrary, Evoqua Water Technologies and its suppliers and any affiliated companies shall not be liable for any consequential, incidental, special, punitive or other indirect damages, and Evoqua Water Technologies total liability arising at any time from the sales of use of the equipment shall not exceed the purchase price paid for the equipment. These limitations apply whether the liability is based on contract, tort, strict liability or any other theory.

2.6 Disclaimer

We are not liable for any damages incurred during installation or use of these hardware and software components. This applies specifically to trouble-free interaction with the software and hardware components you choose.

We are not liable for buyer damages (in particular, lost profits, lost information and service interruptions), which arise when using the Blu-Sentinel™ Pro flow cell, nor for other damages. You are solely responsible for the installation!

The contents of the instruction manual has been checked to make sure that it matches the detailed hardware and software. Deviations can nevertheless not be ruled out and we therefore assume no liability for full conformity. The details in this instruction manual are checked regularly and any necessary corrections are included in subsequent issues.

3. Description

3.1 General

The Blu-Sentinel™ Pro electronics module (module type E01) is part of the Blu-Sentinel™ Pro Pool Management System.

The Blu-Sentinel™ Pro electronics module (module type E01) in conjunction with the Blu-Sentinel™ Pro flow cell (module type D01) and the integrated sensors, measures and controls the disinfection parameters free chlorine, pH value, ORP voltage, as well as total chlorine, conductivity and temperature.

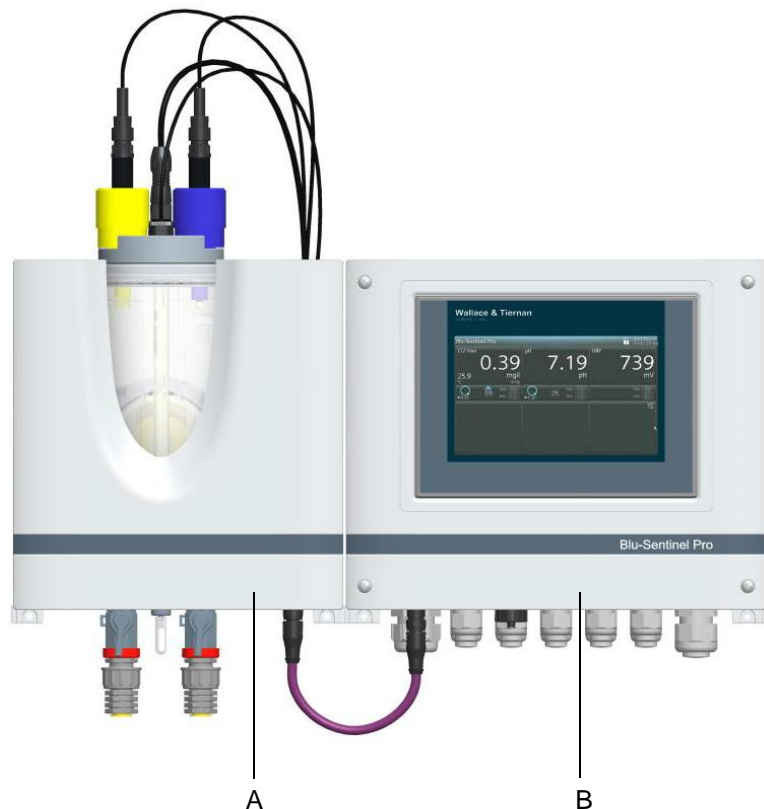

Image 1 Blu-Sentinel™ Pro Pool Management System with sensors

A Blu-Sentinel™ Pro flow cell with sensors

B Blu-Sentinel™ Pro electronics module

The integrated process control provides a complete pool management with the following functions:

- Dosing of disinfectants either conventionally or CEDOX-controlled
- Adaptation to the volume flow (ECO mode)
- Correction of the pH value
- Control of the powder activated carbon system or UV system
- Addition and calculation of flocculants (controlled by circulation and the pH value)
- Control of the conductivity in brine applications (optional)
- Limit value monitoring
- Data transfer to superordinate systems
- Time-controlled, controlled peak chlorine function
- Display of dosing quantity, e.g. for gas systems

3.2 Version

The Blu-Sentinel™ Pro Pool Management System (part no. W3T385932) consists of:

- Blu-Sentinel™ Pro electronics module (module type E01)
- Blu-Sentinel™ Pro flow cell (module type D01)
(pressurized version)
contains the DFMe electronics
- Free chlorine sensor
- pH electrode (yellow)
- ORP electrode (blue)

Optional:

- Total chlorine membrane sensor TC3 CAN

NOTICE

The Blu-Sentinel™ Pro flow cell can be retrofitted with the total chlorine membrane sensor TC3 CAN. Please note that the standard cell body cover must be replaced by an optional cell body cover, part no. W3T409581.

3.3 Design

The Blu-Sentinel™ Pro electronics module (module type E01) essentially consists of:

- Plastic housing with removable housing cover
- Motherboard with power supply, terminal strips, electronic components and relays
- Operating and display panel (HMI)
- Cable glands
- CAN connection

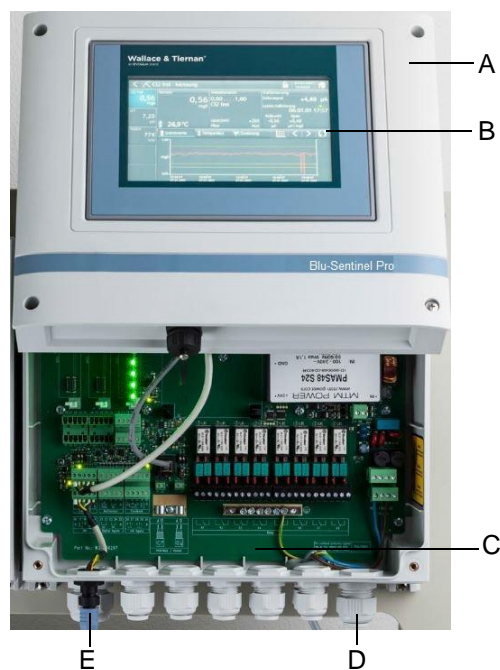

Image 2 Blu-Sentinel™ Pro electronics module with open cover

- A Plastic housing
- B Control and display unit
- C Motherboard
- D Cable glands
- E CAN connection

3.4 Functions

The Blu-Sentinel™ Pro electronics module together with the Blu-Sentinel™ Pro flow cell and the sensors, is used to measure and control the disinfection parameters in swimming pool applications.

Typical examples of applications:

- Measurement and control of chlorine and pH in the swimming pool
- Actuation of chlorine gas metering systems or dosing pumps
- Monitoring and raising of alarm if limit values exceeded
- Data visualization
- Data transfer to superordinate systems

Potential process measurements include:

- Free chlorine
- pH
- ORP voltage
- Total chlorine/combined chlorine
- Conductivity (optional)
- Temperature
- Actuator feedback

The color touch display shows the following:

- Measurement values
- Operation mode and switching states
- Display of limit values
- Setpoint and measurement range
- Customer-specific measuring point designation
- Messages and errors
- Date/Time
- Trending

The menus are used by means of direct entry on the display or by touching the display. A trend screen displays past measurements for all sensors.

To connect to visualization systems, 4 mA outputs (optional), an RS485 interface and an Ethernet interface are available.

3.4.1 Controller Outputs

The Blu-Sentinel™ Pro electronics module supports the following controller outputs:

Controller for	Type	Parameter designation	Action
Positioner with feedback	3-Point	Positioner with Ym	Dosing Cl ₂
Positioner without feedback	3-Point	Positioner without Ym	Dosing Cl ₂ Correction pH ↑
Motor dosing pump (pulse duration controller)	2-Point	Dosing pump 2P	Dosing Cl ₂ Correction pH ↓ or pH ↑ Corr. conductivity ↑ Combined Cl ₂ ↑ or ↓
2 motor dosing pumps (pulse duration controller)	3-Point	Dosing pump 3P	Correction pH ↓ or pH ↑
Pulse pump (pulse-frequency controller)	2-Point	Solenoid pump 2P	Dosing Cl ₂ Correction pH ↓ or pH ↑ Corr. conductivity ↑ Combined Cl ₂ ↑ or ↓
2 solenoid pumps (pulse-frequency controller)	3-Point	Solenoid pump 3P	Correction pH ↓ or pH ↑
Dosing pump with mA input	2-Point	Analog output 2P	Dosing Cl ₂ Correction pH ↓ or pH ↑ Corr. conductivity ↑ Combined Cl ₂ ↑ or ↓
2 dosing pumps with mA input	3-Point	Analog output 3P	Correction pH ↓ or pH ↑
Powder activated carbon system/ UV system, release of control input	2-Point	Dosing contact	Combined Cl ₂ ↓ pH ↑ or pH ↓ Dosing Cl ₂ Corr. Conductivity ↑
Control of a flocculant dosing			

Positioner (with and without feedback)

With the selection of the integrated controller for "positioner", for example, it is possible to use chlorine overfeed control in connection with a positioner as an actuator of a chlorine gas dosing system.

2-point pulse duration controller for dosing pumps

The dosing pump is switched on for the calculated time within an adjustable cycle period T_p (relay contact).

The cycle period is mainly determined by the reaction time of the connected system and entered as the cycle period T_p .

Example:

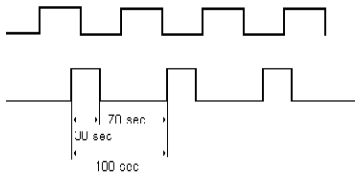

Cycle period T_p	=	100 s
Output value Y_{out}	=	30 %
=> Duty cycle		30 s
Off-duty cycle		70 s

2-point pulse frequency controller for pulse pumps

Pulse pumps are controlled with 0 to 100/120/140/160/180 pulses per minute, depending on the specification of the connected pump.

The duty cycle during each dosing is 0.3 s. The break time is calculated to be between 0.2 and 60 s, depending on the dosing rate.

Example of a pulse pump at 120 pulses/min:

Yout in %	100...	84...	72...	56	50...	33...	25...	10...	5...	1	0
Pulses/min	120...	96...	85...	75	60...	40...	30...	12...	6...	1	0

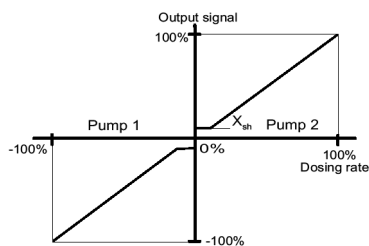
3-point pulse duration controller for dosing pump and 3-point pulse frequency controller for Pulse pump

Pump 1 decreases the control value,
Pump 2 increases the control value.

The control range is between -100 % (Pump 1) and +100 % (Pump 2); this range can also be set in manual mode.

If the setpoint = actual value, no pump is activated (neutral zone X_{sh}).

Output signals as for 2 point pulse-duration controller and 2-point pulse-frequency controller.

Controller with mA output

The Blu-Sentinel™ Pro electronics module has a maximum of four analog mA outputs. These can be assigned individually as registration or controller outputs or as controller output when selecting "Analog output 2P" or "Analog output 3P" it is necessary to assign the desired mA output 1 to 4.

Analog output controller 2-point

With a control output of 0%, the output current is 0 or 4 mA; with a higher control output, the output current reaches up to 20 mA. Pumps with current input, thyristor control units with DC or AC pumps, or analog control valves can be used as actuators.

Analog output controller 3-point

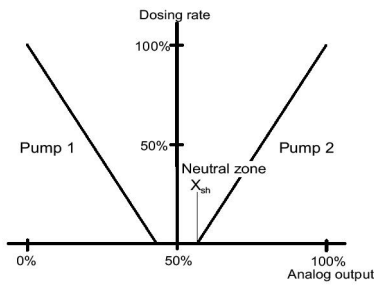

Pump 1 decreases the control value,
Pump 2 increases the control value.

Output behaviour is similar to "Analog output controller (2-point)", but with 50 % offset. This means that with a control deviation of 0 % (setpoint = actual value) a current of 10 mA or 12 mA is output (pump is idle).

Setting	Signal	Pump	Signal	Pump
0 to 20 mA	0 to 10 mA	Pump 1	10 to 20 mA	Pump 2
4 to 20 mA	4 to 12 mA	Pump 1	12 to 20 mA	Pump 2

Therefore, two suitable pumps can be actuated with one mA current loop.

Dosing contact

A dosing contact is used to actuate electrolysis systems for chlorine dosing or to reduce the combined chlorine in the water with powder activated carbon dosing systems or UV systems. A special controller is required to drive these systems in order to prevent frequent switching on or off (on account of flushing times on powder activated carbon systems, cooling phases on UV systems).

The contact is enabled or disabled within the set control parameters.

If the CI-N value entered is exceeded (e.g. 0.20 mg/l), the controller output switches on for at least the minimum duty cycle. As long as the CI-N value is exceeded, the controller output remains on. When the CI-N value is not reached, the controller output switches off immediately (provided that the minimum duty cycle has elapsed).

Renewed activation when the setpoint is exceeded is only possible when the minimum off-duty cycle has elapsed.

NOTICE

In manual mode the minimum duty cycle and the minimum off-duty cycle are ignored!
For dosing contact, there is no monitoring of the max. dosing time.

Controller STOP function

When the controller STOP function is active, all controller outputs are switched off (positioner closed, dosing pump off, pulse pumps off, analog output controller 0%, enabling contact off, dosing contact off).

The flocculation output is also switched off.

The DIN function remains active as long as the DIN limit values are kept.

Controller STOP is triggered by the digital inputs, e.g. by sample water STOP or circulation off.

3.4.2 Control parameters

Control parameters are setting values used to determine the control response of a controller. Different parameters apply depending on the type of controller.

NOTICE

The control parameters are listed alphabetically.

Pulses max./min

Maximum number of pulses	
Description	The max. pulses/min parameter only applies to pulse pumps. This parameter is used to set the maximum number of pulses per minute in accordance with the pump used.
Setting range	The max. pulses/min parameter can be set to 100/120/140/160/180 pulses.

Setpoint

Setpoint	
Description	Specified value at which the control value (chlorine, pH, total chlorine, conductivity) can be maintained by the controller.
Setting range	The setting range corresponds to the respective measuring range.

T_n

Integral action time (I-element)	
Unit	Minutes (min)
Description	On the basis of the integral action time <i>T_n</i> , the dosing rate changes constantly until the set-point is reached. The higher the value of <i>T_n</i> , the longer it takes until the controller increases the dosing rate. <i>T_n</i> higher: Control response is slower <i>T_n</i> lower: Control response is faster
Setting range	The parameter <i>T_n</i> can be set from 0 to 100 min (<i>T_n</i> = 0 means that the "I-element" is deactivated, i.e. a pure P-control response applies). It may not be possible to reach the setpoint value.

T_p

Cycle period	
Unit	Seconds (s)
Description	The parameter <i>T_p</i> only applies to dosing pumps. The cycle period <i>T_p</i> defines a switching period, which must be coordinated with the respective pump type.
Setting range	The parameter <i>T_p</i> can be set between 10 and 180 s.

Example:

Fast dosing pumps can be actuated by a low *T_p*, slow dosing pumps can be actuated by a high *T_p*.

The control parameter *T_p* must always be adjusted to suit the dosing pump used:

Dosing pump	up to 20 strokes/min	20 to 40 strokes/min	40 to 80 strokes/min	80 to 125 strokes/min	125 to 200 strokes/min
<i>T_p</i> value	120	100	60	30	15

NOTICE

If the T_s and T_u values are modified manually, the control parameters X_p and T_n are re-calculated.

 T_s

Loop rise time	
Unit	Minutes (min)
Description	Time required to reach the end value of the measuring range with 100% dosing rate. This time is defined automatically by the system for the automatic adaption, but it can also be entered manually.
Setting range	The parameter T_s can be set between 1.0 and 480.0 min.

 T_u

Loop dead time	
Unit	Minutes (min)
Description	Time required between start of dosing and clear recognition of the reaction. This time is defined automatically by the system for the automatic adaption, but it can also be entered manually.
Setting range	The parameter T_u can be set between 1.0 and 60 min.

 T_y

Running time of the positioner	
Unit	Seconds (s)
Description	The parameter T_y only applies to positioners. T_y is the time which the positioner requires to adjust from 0 % to 100 %.
Setting range	The parameter T_y can be set between 10 and 180 s.

Control direction

Control direction	
Unit	Acid / Alkali for pH Raising/lowering for conductivity
Description	Defines which medium is used to perform the correction.

Example:

pH	for control direction "Acid"	Lower pH value when adding acid
Conductivity	for control direction "Raise"	Addition of salt

Xp

Proportional factor	
Unit	Percentage (%) with factor
Description	<p>The control amplification is determined by means of the proportional factor.</p> <p>The lower the proportional factor Xp is selected in %, the greater the deviation from the setpoint is amplified, and the more quickly the controller attempts to control the deviation from the setpoint.</p> <p>The control amplification factor is calculated using the following equation: Factor = (1/Xp) x 100 %</p>
Setting range	The parameter Xp can be set from 1 % (factor 100) to 1000 % (factor 0.1).

Xsh

Neutral zone	
Unit	Percentage (%)
Description	<p>The parameter Xsh only applies to 3-point controllers.</p> <p>There is no control output within the neutral zone.</p>
Setting range	The parameter Xsh can be set from 1 to 5 % (based on the measuring range).

NOTICE

The control range is limited by the parameters Ymax and Ymin.
Do not select a Ymax value lower than Ymin.
With Ymin > 0 overdosing can occur.

Ymax

Dosing rate limitation	
Unit	Percentage (%)
Description	<p>The parameter Ymax only applies to</p> <ul style="list-style-type: none"> • Positioner with feedback • Dosing pumps • Pulse pumps • Controller with mA output <p>Ymax defines the maximum control output to the actuator</p> <p>The control parameter corresponds to electronic dosing limitation of the actuator.</p>
Setting range	The parameter Ymax can be set from 0 to 100 %.

Ymin

Dosing rate basic load	
Unit	Percentage (%)
Description	<p>The parameter Ymin only applies to</p> <ul style="list-style-type: none"> • Positioner with Ym feedback • Dosing pumps 2P • Pulse pumps 2P • Controllers with mA output <p>A basic dosing rate is output to the actuators via Ymin.</p>
Setting range	The parameter Ymin can be set from 0 to 100 %.

3.4.3 Controller modes for chlorine control

The Blu-Sentinel™ Pro electronics module offers two options for controlling the concentration of disinfectants:

- Cl₂ single feedback closed loop control
- CEDOX control

Cl₂ single feedback closed loop control

In this mode, the required Cl₂ value is held at the setpoint using the PI single feedback closed loop control (standard chlorine regulation).

CEDOX control

In this mode, the chlorine setpoint is continuously and automatically optimized using a PI single feedback closed-loop control in order to maintain a constant ORP value. For this procedure, the setpoint entered is not Cl₂ as normal, but the required ORP voltage is set as the setpoint. A specially developed CEDOX mode calculates the amount of free chlorine required in the water based on the demand. This internal chlorine setpoint is used to measure the required quantity of disinfectant using the PI single loop feedback controller.

The variable or optimized Cl₂ setpoint must remain between the “Min setpoint” and “Max setpoint” limit values.

NOTICE

DIN 19643 (DIN = German Industrial Norm) stipulates the following Cl₂ limit values: Min = 0.30 mg/l and Max = 0.60 mg/l.

Requirement for CEDOX control:

- Chlorine measuring and control
- pH measuring and control
- ORP measurement

NOTICE

CEDOX control only works if the pH value deviates from the pH setpoint by no more than 0.30 pH

The CEDOX control system is based on the following principle:

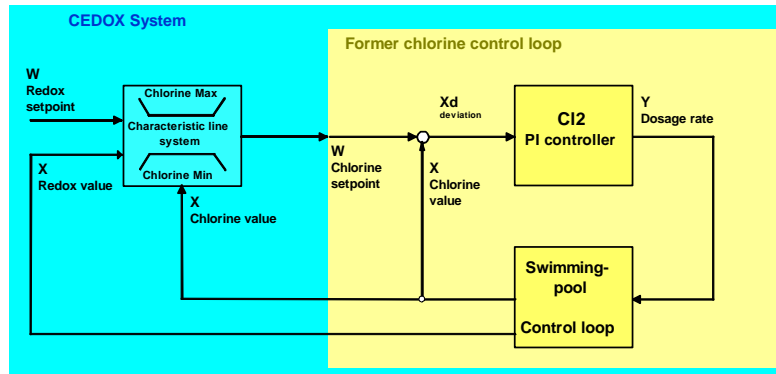

Image 3 CEDOX curve system

The example diagram below shows how the CEDOX mode works:

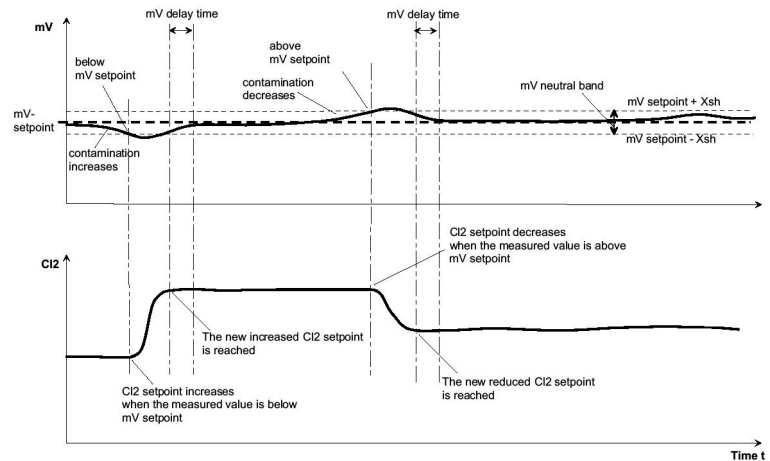

Image 4 Operating principle of the CEDOX operating mode

Notes for settings for CEDOX control:

In CEDOX mode, an ORP setpoint is generally set. A neutral band X_{sh} defines what the maximum deviation from the ORP setpoint is. If the deviation is greater than X_{sh} , the Blu-Sentinel™ Pro electronics module defines a new Cl_2 setpoint.

The parameter "ORP delay time" defines the reaction time of the ORP electrode (blue) and has a delaying effect on the setpoint optimization of the chlorine control.

The Cl_2 setpoint values defined by the CEDOX operating mode must remain between the limit values of the "Cl2 min. setpoint" and the "Cl2 max. setpoint." If these setpoint limits are reached, the ORP measured value may vary from the ORP setpoint.

Notes for startup and calibration of CEDOX control

After calibrating the ORP electrode (blue), the setpoint optimization is out of service for 2 hours, as the ORP electrode (blue) does not supply reliably signals during this period. During this time, the Blu-Sentinel™ Pro electronics module uses a fixed temporary Cl₂ setpoint. This temporary Cl₂ setpoint is the last current Cl₂ before the calibration (can be altered manually).

When the chlorine measurement is calibrated, the Blu-Sentinel™ Pro electronics module automatically calculates a new Cl₂ setpoint if deviations are detected.

The following is achieved by using CEDOX:

- Reduction of disinfectant consumption (as much chlorine as necessary but as little as possible).
- The optimum control of the Cl₂ setpoint based on the ORP voltage means that the lowest possible Cl₂ setpoint is always used and thus disinfectant saved.
- Optimizing the water quality, especially in swimming pools with heavy fluctuations in usage (e.g. outdoor pools) or with long periods of no usage.

NOTICE

CEDOX does not mean that disinfection systems can be made smaller!

3.4.4 Combinations of controller modes

The Blu-Sentinel™ Pro electronics module gives you the option of running various controller modes in combination with ECO mode.

The operator can select three different controller modes:

- Cl₂ single feedback
- CEDOX
- Cl₂ + ECO-CEDOX

Cl₂ single feedback

Normal mode: Cl₂ setpoint
ECO mode: Cl₂ setpoint ECO

Cl ₂ setpoint	
Description	In this mode, the required Cl ₂ value is held at the setpoint using the PI single feedback closed loop control.
Setting range	Xp, Tn, setpoint

Cl ₂ setpoint ECO	
Description	<p>In ECO mode, the reduced Cl₂ value is held at the setpoint using the PI single feedback closed loop control. There is a digital input to switch the system to ECO mode.</p> <p>The flocculation control system measures at a constant rate.</p> <p>This ECO mode can also be used for disinfectant control in combination with reduction of the circulation.</p>
Setting range	Setpoint ECO, Xp _{ECO} , Tn _{ECO}

CEDOX Normal mode: CEDOX
 ECO mode: CEDOX_{ECO}

CEDOX	
Description	<p>In this mode, the setpoint entered is not Cl₂ as normal, but the required ORP voltage is set as the setpoint. The specially developed CEDOX mode calculates the amount of free chlorine required in the water based on the demand. This internal Cl₂ setpoint is used to measure the required quantity of disinfectant using the PI single loop feedback controller.</p> <p>The flocculation control system measures at a constant rate.</p>
Setting range	ORP setpoint, X _p , T _n

CEDOX _{ECO}	
Description	<p>In CEDOX_{ECO} mode, the mode is also controlled based on the ORP setpoint. There is a digital input to switch the system to ECO mode. The Blu-Sentinel™ Pro electronics module calculates the required concentration of free chlorine in the water based on load and controls this Cl₂ setpoint using the PI single loop feedback control.</p> <p>The flocculation control system measures at a constant rate.</p> <p>This ECO mode can also be used for disinfectant control in combination with reduction of the circulation.</p>
Setting range	ORP setpoint ECO, X _{pECO} , T _{nECO}

$Cl_2 + ECO-CEDOX$

Normal mode: Cl_2
 ECO mode: $CEDOX_{ECO}$

Cl_2	
Description	In this mode, the Cl_2 setpoint is controlled by a PI single feedback closed loop control. The flocculation control system measures at a constant rate.
Setting range	X_p , T_n , Cl_2 setpoint

$CEDOX_{ECO}$	
Description	In $CEDOX_{ECO}$ mode, the mode is controlled based on the ORP setpoint (see under CEDOX). There is a digital input to switch the system to ECO mode. The flocculation control system measures at a constant rate. This ECO mode can also be used for disinfectant control in combination with reduction of the circulation.
Setting range	ORP setpoint $_{ECO}$, X_{PECO} , T_{nECO}

3.4.5 Limit contacts

The limit values are issued via relay contacts and the color display. The number of available limit contacts depends on the configuration. A maximum of 8 limit contacts are possible. The additional relay board provides a further 4 limit contacts.

Each limit contact can be assigned the following functions:

Limit value = Min	=>	all measuring values can be selected individually (Cl ₂ , pH, ORP, Cl-N, conductivity, temperature)
Limit value = Max	=>	all measuring values can be selected individually (Cl ₂ , pH, ORP, Cl-N, conductivity, temperature)
Digital inputs	=>	1 to 3 can be selected individually
Errors		
Sample water STOP		
circulation	=>	Circulation controller STOP

Unlatched limit contact without acknowledgment option

- The symbol lights up in the event of an alarm and goes out automatically when the condition is eliminated.
- The same applies to the contact.

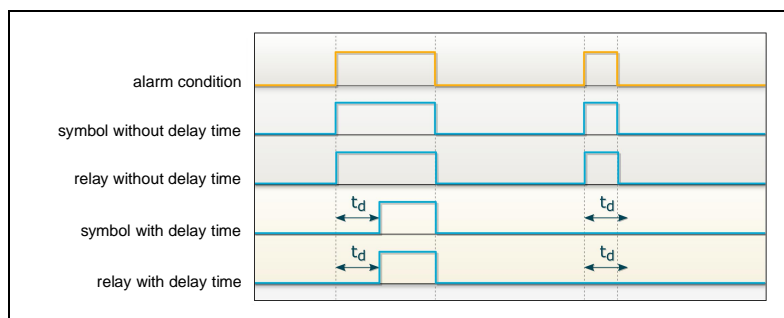

Image 5 Unlatched limit contact without acknowledgment option

Latched alarm with reset acknowledgment option

- The symbol flashes in the event of an alarm until it is acknowledged.
- The symbol also goes out even if the conditions still apply when the alarm is acknowledged.
- The relay is inactivated, even if the condition still applies.

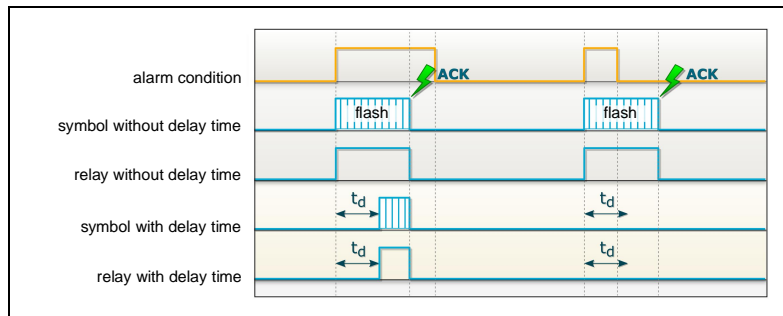

Image 6 Latched alarm with reset acknowledgment option

Latched alarm with acknowledgment (acknowledgment option)

- The symbol flashes in the event of an alarm until it is acknowledged.
- If the condition is no longer present when the alarm is acknowledged, the symbol disappears.
- If the condition is still present when the alarm is acknowledged, the symbol is reset from flashing to a permanent state. The symbol lights up until the condition is eliminated (auto-reset).
- The relay is only inactivated if the condition is eliminated.

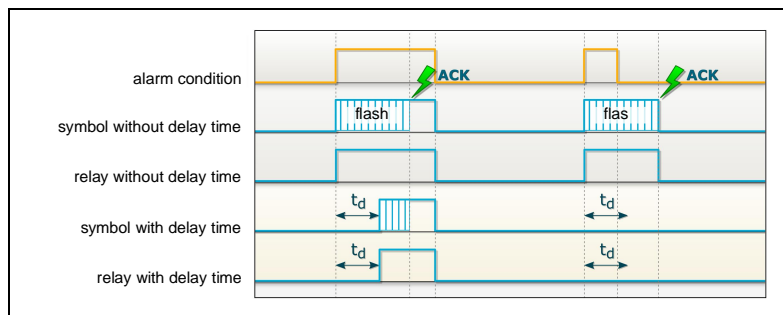

Image 7 Latched alarm with acknowledgment (acknowledgment option)

3.4.6 Interfaces

The following interfaces are available:

- CAN interface
- RS485 interface
- USB interface
- Ethernet interface/Modbus TCP interface

NOTICE

The interfaces are described in detail in Chapter 4. “Interfaces”.

3.4.7 Actuator feedback

The actuator feedback of the Blu-Sentinel™ Pro electronics module is set at the factory to potentiometers with 1 kOhm. The device must be configured via DIP switch S4 (see A&C board) for other feedback signals.

Potential signals include:

- Potentiometer 1 kOhm
- Potentiometer 5 kOhm

Switch settings DIP switch S4:

	S4-A 1	S4-B 2	S4-C 3
Potentiometer 1k	OFF	OFF	ON
Potentiometer 5k	OFF	OFF	OFF

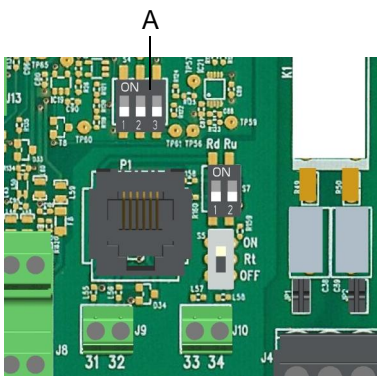

A DIP Switch

3.4.8 Digital inputs

Three digital inputs are integrated in the Blu-Sentinel™ Pro electronics module A&C board. These inputs are provided for connecting voltage-free contacts (< 100 Ohm) and have an internal 5V power supply.

⚠ WARNING

Do not apply a voltage to the digital input terminal!

3.4.9 Relay outputs

The Blu-Sentinel™ Pro electronics module has a maximum of eight or twelve relays, each with a changeover contact. These switches are assigned various switching tasks depending on the respective application. The corresponding diagrams are defined in Chapter 8. "Wiring Diagrams". In order to switch larger inductive loads, we recommend installing an additional switching element such as a contactor or load relay to guarantee the contacts have a longer service life.

The relay contacts of the alarm or controller outputs are factory-protected by RC elements. These provide radio interference suppression for inductive loads such as pumps, motors, etc.

Connecting small loads

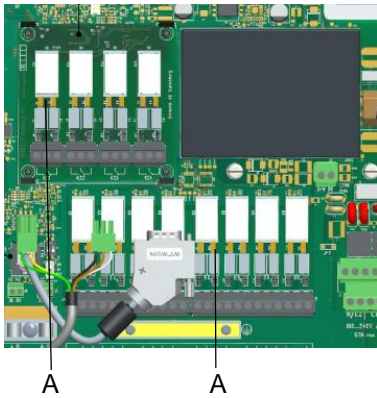

A plug-in jumpers

When connecting small loads to a power supply, such as contactors or servomotors with low power consumption, e.g. V10K, the quiescent current through the RC elements may be sufficient to activate the load (hum of the servomotor, contactor does not drop out, etc.). In this case, the plug-in jumpers of the relevant contacts should be removed to deactivate the RC circuits.

			4-way relay, additional board:
K1	JP1/2	K5	JP9/10
K2	JP3/4	K6	JP11/12
K3	JP5/6	K7	JP13/14
K4	JP7/8	K8	JP15/16
		K21	JP1/2
		K22	JP3/4
		K23	JP5/6
		K24	JP7/8

NOTICE

When using internal power (L1 and N/L2) for power supply of dosing machines or external devices the power consumption must not be higher than 6 A in total.

3.4.10 Adaption (only applies to free Cl₂)

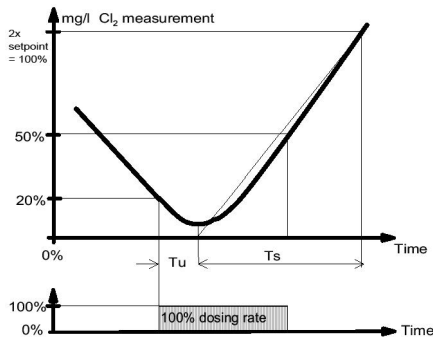

The adaption programme automatically determines the control parameters for free chlorine during commissioning. The adaption can be run separately for normal operation and ECO mode in order to find the suitable controller parameters for both operating modes.

Application

The adaption is used for automatic ascertainment of the reaction times of the control loop (loop dead time T_u and loop rise time T_s) or the resulting control parameters X_p and T_n .

NOTICE

The control parameters X_p and T_n ascertained by the adaption must be considered as a recommendation for the first commissioning! The control parameters X_p and T_n can be manually optimized to ensure maximum control quality.

Requirements

The following requirements must be met:

- Positioner set to automatic (manual wheel engaged)
- Dosing pump set to automatic
- Calibrated Cl₂ measuring (zero point and DPD value)
- Loop dead time < 60 min
- Loop rise time < 480 min (8 h) for 0 to 100 % measurement range
- Decomposition time < 480 min (8 h) of the current measuring value to 20% of the 2x setpoint
- Correct menu setting of the end value, control direction (direct or inverse), actuator (e.g. positioner), positioner running time (T_y)

Adaption may not be started:

- If a large volume of fresh water is being added
- If the measuring cell has not been run in
- During cleaning work
- During filter backwashing
- While the circulation changes
- During peak chlorination

Starting adaption

To start the adaption, proceed as follows:

- 1 Call up the basic screen.
- 2 Press the menu field Parameter "Cl2 free".
- 3 Press the menu field "Functions".
- 4 Press the menu field "Adaption".
The loop parameters Tu, Ts, Tu_{ECO} and Ts_{ECO} will be shown.
- 5 In the menu "Cl2 free – Adaption", press the "Start" button.
The current phase (13 in total) of the adaption is displayed.
- 6 Confirm the adaption required with "ADAPTION OK".
- 7 Press the Home key and the screen changes to the basic screen.

*Error message during adaption*

If adaption is not successful, the error message "ADAPTION?" is displayed. The reason for this may be problems with the dosing system or loop times. Errors must be rectified in order to continue with the adaption. See also "Completing adaption with errors" on page 39.

Adaption sequence

Each adaption phase is then displayed with a status message:

Display text	Explanation
1: Initialization	Start
2: Control signal Ym = 0%	Chlorinator to 0 % or dosing pump off
3: Wait of act. value X = 20%	Delay until actual value < 0.2 x end value
4: Set control signal 100%	Chlorinator to 100 % or dosing pump on
5: Wait of control signal 100%	Wait until chlorinator reaches 100 %
6: Init. dead time measurement Tu	Start dead time measurement
7: Dead time measurement Tu	Measurement of the loop dead time Tu
8: Check dead time Tu	Plausibility enquiry dead time
9: Calculate initial value Ts	Start of rise time measurement
10: Measure peak-time Ts	Measurement of the loop rise time Ts
11: Calculate parameter	Calculate control parameters
12: Set control signal Y = 0%	Chlorinator to 0 % or dosing pump off
13: Wait of control signal 0%	Wait until chlorinator reaches 0 %

Various status messages can be displayed, depending on the selection of the actuator. Different status messages also have different execution times. It is possible that some status messages are only displayed briefly or not at all if the execution time is very short.

⚠ CAUTION

Adaption can take up to 13 hours, depending on the control loop. During this time no errors should occur on the control loop (e.g. filter backwashing, changes in the circulation or widely fluctuating number of visitors).

NOTICE

The adaption procedure can be terminated at any time with "CANCEL". The previously set parameters remain unchanged.

Completing adaption without errors

When the loop times (dead time T_u and rise time T_s) have been completed without error, calculation of the control parameters X_p and T_n commences. This is shown by "ADAPTATION OK". The calculated parameters are entered in the menus. When adaption has been concluded, the measuring amplifier adjusts with the newly calculated control parameters and continues in the selected operating mode (e.g. automatic).

To monitor the determined loop times they are entered into the "Tu" and "Ts" menus .

If any errors in the control loop do occur during adaption (e.g. filter backwash or changes in the circulation speed), this may lead to incorrect loop times, resulting in wrong control parameters being determined.

⚠ CAUTION

The remaining control parameters Y_{min} , Y_{max} and T_p are not influenced when adaption is performed. The control parameters X_p and T_n are determined for $Y_{min} = 0\%$ (no basic load) and $Y_{max} = 100\%$ (no dosing rate limitation). Depending on the system, if a basic load Y_{min} or a dosing rate limitation Y_{max} is required, remember that the control range is restricted. There is then the risk of excessive chlorination (Y_{min} too high) or inadequate chlorination (Y_{max} excessively limited).

Completing adaption with errors

If errors occur in the control loop during adaption (e.g. filter backwashing, changes in the circulation or widely fluctuating number of visitors to the pool) or if the reaction times of the control loop are too long, adaption is interrupted.

NOTICE

If any of the error conditions described below occur, adaption is interrupted. The measuring amplifier displays one fault message. The "old" parameters X_p and T_n are not changed.

Possible error messages:**Initial value not reached (display: "T = > 8h")**

When adaption has started and the dosing system has closed or the dosing pump has switched off, the measuring amplifier waits until the actual value has dropped below the initial value (0.2 x the measurement range value). This delay is indicated by "2: X = 20 %" being displayed and must not exceed 8 hours.

Loop dead time too long (display: "Tu = > 1h")

The value determined by the time measurement between starting up the dosing, switching on the dosing pumps and the rise of the actual value may only take a maximum of 1 hour. This measured time is displayed by "6: Tu!".

Loop rise time too long (display: "Ts = > 8h")

The time is determined by a measurement, which the control loop requires at a 100 % dosing rate of the dosing system or the dosing pump, to increase the actual value to 50 % of the measuring range. This measurement is indicated with "9: Ts!" and may take a maximum of 4 hours.

Determination of the control parameters with known Tu and Ts times

If the loop times Tu and Ts are already known or if these cannot be determined automatically due to specific system conditions, the loop times can be entered into the "Tu" and "Ts" menus. When Tu or Ts are saved, the control parameters Xp and Tn are also calculated and entered in the menus.

3.4.11 Flocculation control

In the "Input/Output" menu, an output "Flocculation" can be defined. This output is used for example to drive a dosing pump for flocculant dosing.

"Signal default" setting

The dosing rate with which the flocculation output doses the chemical is calculated automatically in % with the input parameters, dosing rate of the pump, and amount of flocculant added.

"Signal default with ECO" setting

For reduced circulation a second dosing capacity (50 %) is calculated at the same time. Both dispensing rates can also be entered directly. To activate the second dosing capacity (ECONOMIC), assign the function "Changeover ECONOMIC" to one of the digital inputs. An external contact (NC) with the function "Circulation lowered" must be connected to the corresponding DI.

"Circulation" or "mA input 2" setting

In this setting, the dosing rate of the flocculation pump according to the measured flow rate signal is linearly controlled (see configuration of the analog inputs on page 104).

An output for dosing pump 2p, pulse pump 2 or an analog mA output (optional) is available for the dosing. Cycle period, number of pulses or mA signal can be selected.

NOTICE

Flocculation is only active if the measured pH value is within a defined range (6.00 to 8.00). These values can be set the "Flocculation" menu.

If the pH measurement is not available, the flocculation function is not supported!

The flocculation output is linked to the controller operating mode of the chlorine controller and is only active if the chlorine controller is working in Automatic mode.

With "Controller STOP" of the chlorine controller, the flocculation output is not active.

3.4.12 DIN/ECO contact

The DIN contact (GERMAN INDUSTRIAL NORM) refers to water quality parameters that have to be met for pool water regulations in place in Germany. The DIN water quality parameters are shown below:

- Cl₂ => 0.3 to 0.6 mg/l
- pH => 6.5 to 7.6
- ORP => 750 mV
- Cl-N => 0.2 mg/l
- Hysteresis for all measurements 0.03

NOTICE

The DIN contact default values can be adjusted to meet your local pool water quality guidelines.

ECO mode primarily refers to operating the pool's recirculating pump motors at a reduced rate. The recirculating pumps must be fitted with variable frequency drives to enable this function.

The DIN contact can also be used time-controlled as ECO contact via the internal ECO timer function, when in the menu field "DIN/ECO function" "ECO Timer" is selected. If the function "DIN function" is selected in addition, the condition of the DIN function must be met as well for the DIN/ECO relay to switch.

If all pool water quality parameters are within the adjusted DIN contact limits the following functions can be enabled:

- Enabling of circulation reduction in conjunction with a filter control
- A visual signal "Water quality good/bad".
- It is possible to switch to ECO parameter via digital input 1 to 3

NOTICE

The function is only available if there is a Cl₂, pH and ORP measurement.

If there is no Cl-N measurement, the DIN function is provided without Cl-N measuring value.

The DIN contact remains active in spite of "Controller STOP" as long as the measuring values are within the DIN limits.

3.4.13 ECO mode

The Blu-Sentinel™ Pro electronics module offers several ways to switch to ECO mode (see "ECO mode" on page 95). There is the option to switch to a different setpoint (setpoint ECO), different control parameters or to CEDOX mode.

If necessary, e.g. during the night, circulation is reduced, i.e. the Blu-Sentinel™ Pro electronics module, when in ECO mode, switches to ECO parameter, ECO setpoint or if the relevant setting is realized, to CEDOX mode. Flocculant dosing is also switched to ECO mode.

The setting for the ECO changeover is done with the menu field "Input/Output - Digital Inputs" or "Cl₂ Functions - ECO Mode." The digital contacts DI1, 2, 3 or several internal functions can be configured for the ECO changeover.

3.4.14 Safety functions

The safety functions integrated into the control unit are:

- Safety deactivation if the circulation fails and/or if the dosing tank signals that it is empty and also if the sample water supply fails
- Dosing time monitoring and the feed time delay
- Alarms
- External STOP for all controllers
- “Positioner closed” function in the event of a power failure (only if positioner has external power supply)
- Password protection on two levels

3.4.15 Super-chlorination

This function is primarily an addition in combination with CEDOX control or when low concentrations of chlorine occur frequently.

The “peak chlorination” function allows a super chlorination of the pool water on a scheduled basis. Peak chlorination can also assist in the prevention of algae growth in outdoor pools.

Via a maximum of three freely definable timer, the Blu-Sentinel™ Pro electronics module can automatically adjust to a higher chlorine value, which can even be set to above the measurement range. These switch on times can be activated daily, weekly, or every two, three or four weeks.

The duration of the peak chlorination can be defined and starts when the peak chlorination setpoint is reached.

For safety reasons, the system includes a time limit which defines the maximum time for which this peak chlorination value can be activated. If the peak chlorination value is not reached during this time, the process is canceled and an error message is displayed.

There is the option of switching off the alarm and the overall chlorine control during peak chlorination. Once the Cl_2 value is back at the setpoint, the alarm and the overall chlorine control are reactivated and the „peak chlorination” symbol is no longer displayed.

As long as the setpoint peak chlorination is used and maintained, the HC peak chlorination symbol continues to be displayed as the operating mode symbol for the chlorine control. Chlorine dosing stops after the normal chlorine setpoint is reached again and the super-chlorination symbol is no longer displayed.

3.5 Technical Data electronics module (module type E01)

<i>Housing</i>	Dimensions (WxHxD)	320 x 311 x 153mm
	Weight	approx. 4.5 kg
	Protection rating	IP66
	Mains connection	100 to 240 V AC \pm 10% (50 to 60 Hz, 48 W) or 24 V DC, 30 W

<i>Display</i>	7" graphic color display with backlit LED and resistive touch-screen Resolution 800 x 480 pixels
----------------	---

<i>Insulation</i>	Overvoltage category	2
	Contamination level	2
	Protection category	1

<i>Operating conditions</i>	Ambient temperature	0 to 50 °C
	Humidity	< 80 %, non-condensing
	Environment	No direct sunlight
	Atmospheric pressure	75 to 106 kPa
	Max. working height	2,000 m
	Storage temperature	-20 to +70 °C
	Noise emission	<45 dB

Digital inputs of the Blu-Sentinel™ Pro electronics module

3x for voltage-free contacts (with internal power)	
Freely selectable function in the menu	
When input open	DI active
When input closed	DI inactive

Measurement inputs

<p>1x feedback input for positioner feedback Potentiometer 1 kOhm</p>
<p>CAN sensor input to connect Blu-Sentinel™ Pro flow cell and total chlorine membrane sensor TC3 CAN and SiDiSens conductivity (LF) module to measure the following:</p> <ul style="list-style-type: none"> • Free chlorine • Combined/total chlorine • pH value • ORP voltage • Conductivity (optional) • Temperature (measuring range 0...50°C/32...122°F) • Flow rate monitoring

Relay outputs

<p>8x changeover contacts (optional 4x in addition)</p> <p>Finder relay type</p> <table> <tr> <td>max. continuous current</td> <td></td> <td>6 A</td> </tr> <tr> <td>max. switching capacity</td> <td>AC1</td> <td>1500 VA</td> </tr> <tr> <td>max. switching capacity</td> <td>AC15 (230V)</td> <td>250VA</td> </tr> <tr> <td>max. switching capacity</td> <td>AC3 (230V)</td> <td>185 VA</td> </tr> <tr> <td>max. switching current</td> <td>220V DC</td> <td>0.2 A</td> </tr> <tr> <td></td> <td>30V DC</td> <td>3 A</td> </tr> </table> <p>Panasonic DSP1 relay type</p> <p>5 A, 125/250V AC (general use)</p> <p>1/6 HP (122 VA) 125/250V AC</p> <p>5 A, 30V DC (resistive load)</p> <p>30W max., 1 A, 30V DC – 0.24 A, 125V DC (inductive load)</p> <p>B300</p> <p>For NSF 50 compliance individual relay current must be restricted to 3.15 A - connection of devices with a current draw of higher than 3.15 A avoids NSF 50 certification.</p>	max. continuous current		6 A	max. switching capacity	AC1	1500 VA	max. switching capacity	AC15 (230V)	250VA	max. switching capacity	AC3 (230V)	185 VA	max. switching current	220V DC	0.2 A		30V DC	3 A
max. continuous current		6 A																
max. switching capacity	AC1	1500 VA																
max. switching capacity	AC15 (230V)	250VA																
max. switching capacity	AC3 (230V)	185 VA																
max. switching current	220V DC	0.2 A																
	30V DC	3 A																

NOTICE

When connecting capacitive loads (e.g., load with integrated power supply), an additional contactor with appropriate specification must be provided. When connecting relays to external devices, a 5 A fuse must be provided as overload protection. Typical use of relays: enable contact for dosing device, control of motors or dosing pumps.

Analog outputs

4x mA outputs with mA output card 0/4 to 20 mA
--

freely configurable

Load max. 500 ohm, accuracy < 0.5 % FS
--

Galv. isolated up to 50 V relative to earth

Interfaces

RS485 for connection to ChemWeb server, OPC-server, Process Monitoring system or control system for data visualization
--

Ethernet interface

CAN interface for data communication with the Blu-Sentinel™ Pro flow cell

USB interface for data export, firmware update and system setup download as well as upload.

4. Interfaces

4.1 CAN interface

The Blu-Sentinel™ Pro electronics module is equipped with a CAN interface. The CAN interface acts as a sensor bus to the Blu-Sentinel™ Pro flow cell.

Measuring values are digitally transferred from the Blu-Sentinel™ Pro flow cell to the Blu-Sentinel™ Pro electronics module. The DFMe electronics integrated in the Blu-Sentinel™ Pro flow cell converts the extremely sensitive sensor signals to interference-free digital transfer signals and passes them on to the Blu-Sentinel™ Pro electronics module.

The connection between the Blu-Sentinel™ Pro flow cell and the Blu-Sentinel™ Pro electronics module consists of a four core CAN line with connector. Two cores are for the 24 V DC power supply of the electronics of the sensor and two cores are for CAN data transfer. The cable shielding is the ground connection. The maximum cable length must not exceed 1000 m.



Please note

The CAN interface is electrically isolated. It must not be connected to external bus systems!

Connection CAN connector

Power supply + CAN bus

Connection cable with 5-pin M12 plug and 5-pin M12 socket for CAN bus terminal plug or to connect other CAN bus components

	Pin 1	Screen
	Pin 2	+24V
	Pin 3	0V
	Pin 4	CAN high
	Pin 5	CAN low

CAN connection

The following diagram shows the CAN connection between the Blu-Sentinel™ Pro flow cell and the Blu-Sentinel™ Pro electronics module.

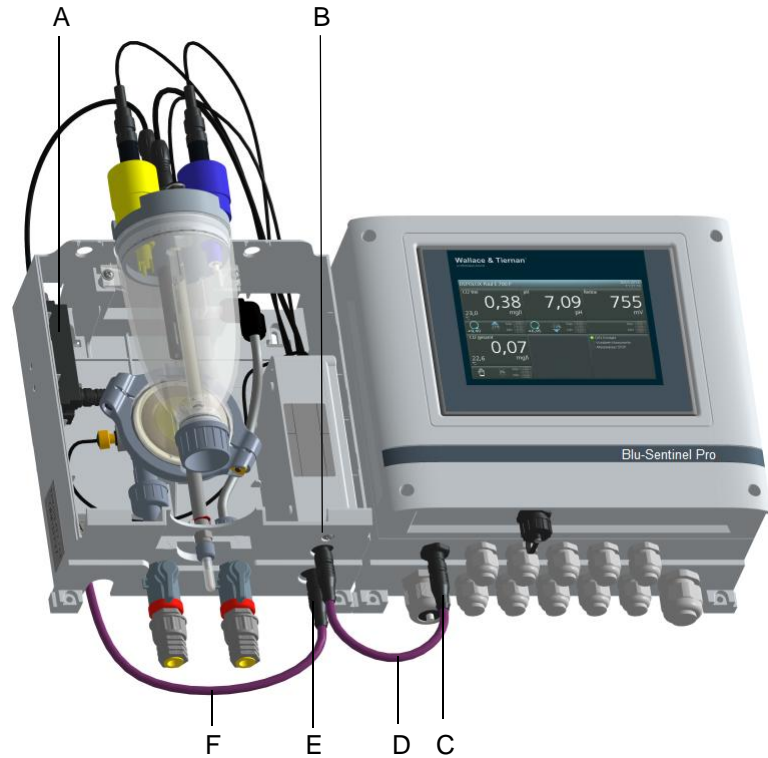

Image 1 Cross-section Blu-Sentinel™ Pro flow cell and Blu-Sentinel™ Pro electronics module

- A *SiDiSens LF module (optional)*
- B *Securing screw, DFMe electronics*
- C *CAN socket for connection of CAN connection cable of the Blu-Sentinel™ Pro flow cell or DFMe electronics*
- D *CAN connection cable*
- E *CAN extension socket*
- F *CAN connection cable for SiDiSens conductivity module (optional) or for the total chlorine membrane sensor TC3 CAN (optional)*

*Please note*

The CAN connection cable of the SiDiSens conductivity (LF) module (optional) is connected to the CAN extension socket for the conductivity measurement.

When retrofitting the conductivity measurement, this extension socket may have to be retrofitted as well.

The total chlorine membrane sensor TC3 CAN (optional) is connected directly to the CAN extension socket, this extension socket may have to be retrofitted as well.

4.2 RS485 interface

The RS485 interface is used for data transfer to superordinate guide systems such as Process Monitoring system or other systems that support the Wallace & Tiernan RS485 protocol. For more detailed information, please refer to the instruction manual “RS485 interface”. These can be requested from your affiliate or download from our website.

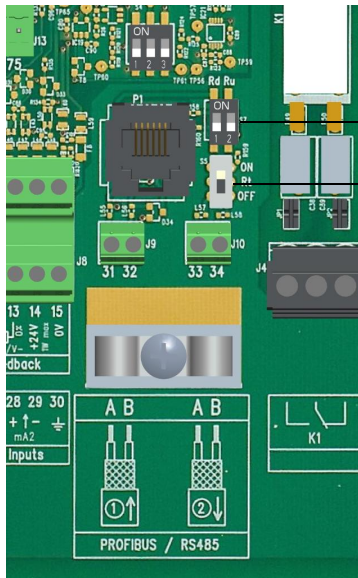

A The RS485 interface is electrically isolated. To integrate into a Wallace & Tiernan bus system, four terminal strips, a terminating resistor R_t and balancing resistors R_u and R_d are integrated.

If the Pool Management system is integrated in an RS485 bus system, then, at the time of installation, the device must be connected to the end of the bus via the terminals 31/32 (1 ↑). When installed in the middle of the RS485 bus, the terminal 31/32 must be used for the incoming bus cable and terminal 33/34 (2 ↓) for the outgoing bus cable.

Image 2 Section of board

- A Dip switch to activate balancing resistors R_u and R_d
- B Dip switch for activating the bus terminating resistor R_t



Please note

When installation is at the end of the bus, the DIP switch R_t must be activated (position ON).
When installation is in the middle of the RS485 bus, R_t must be set to OFF.

A shielded, twisted 2-wire cable (twisted pair) with a wire cross-section of at least 0.25 mm² (24 AWG) must be used as the transfer medium. The characteristic impedance of the cable must be between 100 ohms and 130 ohms, the cable capacity if possible < 60 pF/m. The shielding improves the electromagnetic compatibility (EMC). The bus cable is always wired as a bus from device to device. Any stub cable to the bus device must not exceed a length of 0.3 m. We recommend the cable W2T504634 – LiYCY 2 x 0.25 mm².



Please note

Longer junctions in the bus cable are not permitted!

4.3 USB interface

The Blu-Sentinel™ Pro electronics module is equipped with a USB interface. A USB socket on the bottom of the Blu-Sentinel™ Pro electronics module offers an external connection without having to open the device.

The USB port is used to export data and update the firmware as well as to export and import the parameter settings. Further information can be downloaded from our Homepage.

4.4 Fieldbus connection

Profibus DP

A fieldbus converter is available for connection to a superordinate fieldbus system Profibus DP. Please contact your affiliate if necessary, see chapter 8.1.2 “Fieldbus converter”.

Modbus TCP

The Blu-Sentinel™ Pro electronics module has an integrated Modbus TCP interface, see chapter 4.6 “Modbus TCP interface”.

4.5 Ethernet interface

The Blu-Sentinel™ Pro electronics module has a built-in LAN port. It allows access to data from the Blu-Sentinel™ Pro electronics module via network-compatible devices (PC/laptop) and installed VNC viewer. By connecting to a WLAN router, this provides access to data via various internet-compatible devices, e. g. tablet PCs and smartphones with VNC viewer. This enables 1:1 remote operation, as with the Blu-Sentinel™ Pro electronics module, via the VNC display. The VNC viewer is password protected. The password for the VNC viewer is „100”. In addition, the LAN interface supports data communication with higher-level control systems via Modbus TCP protocol, see chapter 4.6 “Modbus TCP interface”. Both communication options are possible simultaneously.



Please note

This instruction manual does not cover the installation and setup of the Blu-Sentinel™ Pro electronics module in connection with routers. Responsibility lies with the operator.



Please note

The Ethernet interface does not support data connection via Profinet.



Please note

For security reasons, access to the Blu-Sentinel™ Pro electronics module should only be given to authorized personnel. Furthermore, permanent unsafe connections via the Internet or WLAN are not permitted. Safe connections can for example be set up via a VPN secured communication channel or an encoded WLAN connection. The Blu-Sentinel™ Pro electronics module is designed for use in an Intranet (closed network). Please refer to chapter 2.2 "General safety instructions", Section "IT Safety".

The Ethernet connection is designed in accordance with IEEE 802.3. It is designed as an 8P8C socket (often referred to as RJ45 socket) and is screened. Connection to the HUB or switch can be realized with a 1:1-wire and screened patch cable. Direct connection to a PC network card is possible using a patch cable (1:1) or a crossover cable (crossover network cable).

The connection runs in Auto negotiation mode. The data transfer rate and full or half duplex are defined automatically with the connected switch/HUB.

The Ethernet settings of the Blu-Sentinel™ Pro electronics module can be configured via the System settings menu field. In the Ethernet settings menu, you can select whether the IP address is to be automatically assigned or permanently assigned. If permanently assigned, the IP address, Subnet mask and Standard gateway must be entered. To do so, contact the network administrator if the device is being integrated in a network. The MAC address can be found on the back of the HMI but it is also displayed in the Ethernet settings menu.

4.6 Modbus TCP interface

From software version 1.31 onward, the integrated Ethernet interface also supports data communication via Modbus TCP protocol. Various data points are available for data exchange, see chapter 4.6.1 “Data formats”.

Transmission technology	Ethernet in accordance with IEEE802.3
Connection	RJ45 socket, internal
Communication	Supported commands: FC03: Read Multiple Registers FC16: Write Multiple Registers FC06: Write Single Register

The Blu-Sentinel™ Pro electronics module works as a Modbus TCP slave (server). The data packages are transferred as TCP/IP data packages via the Ethernet interface. Access is via the Modbus register. The port used for the communication protocol Modbus TCP is 502. The reference tables have the following structure:

COLUMN	DESCRIPTION
Modbus register	Modbus register address
E-byte	Byte address input data
A-byte	Byte address output data
Module name Profibus DP	Name of the module in the GSD file
Description	Name of the data point
Length	Number of bytes in the data point
Format	Data format of the data point (see chapter 4.6.1 “Data formats”)
Access	Access right R = Read W = Write RW = Read & Write
Description	Additional information on the data point

4.6.1 Data formats

The table below contains the data format used for transmission of the process data:

Data type	Size (bit)	Typical names	Value range min.	Value range max.
INT8	8	yes	-128	127
UINT8	8	no	0	255
INT16	16	yes	-32,768	32,767
UINT16	16	no	0	65,535
INT32	32	yes	-2,147,483,648	2,147,483,647
UINT32	32	no	0	4,294,967,295
FLOAT	32 (8/23) ^{*1}	yes	3,4*10 ⁻³⁸ (-3,4*10 ⁻³⁸)	3,4*10 ³⁸ (-3,4*10 ³⁸)
ASCII	n * 8	no	--	--

*1 Exponent / mantissa

For the byte sequence in which the various data types are saved in the memory or transferred, see the following figures.

Data type INT8 / UINT8

Example using the figure 50 (32 hex):

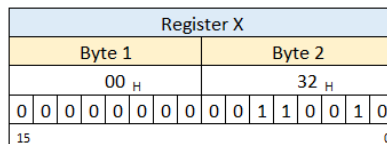

Data type INT16 / UINT16

Example using the figure 12589 (312D hex):

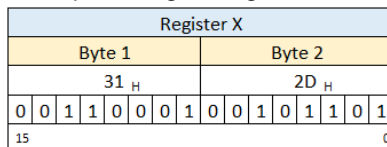

Data type INT32 / UINT32

Example using the figure 1212117675 (483F72AB hex):

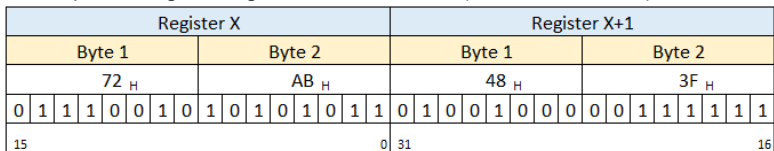

Data type FLOAT

The Float or Real values are transferred in accordance with the IEEE754 Standard Format for 32-bit values. Example using the figure 1.25.

Hexadecimal: 3F A0 00 00 (0: + ; 1: -)
 Signed (S): 0
 Exponent (E): 0111 1111
 Mantissa (M): 010 0000 0000 0000 0000

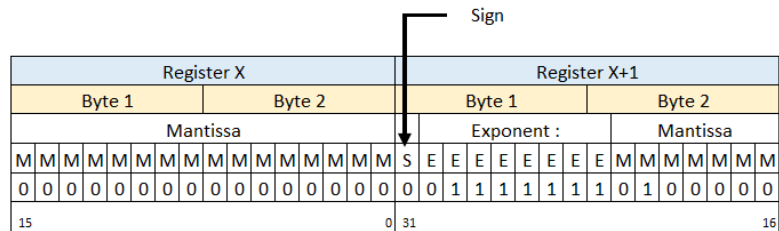
*Data type ASCII*

The characters are transmitted in accordance with ASCII Codepage 437. Example "mg/l"

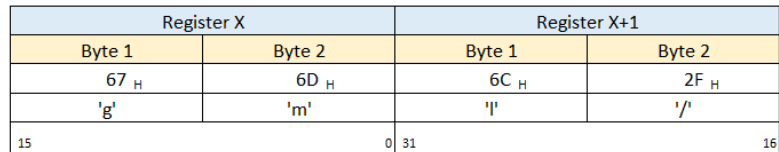

4.6.2 Reference list

The following reference list contains all available data points and values that can be read and written via Modbus TCP. It must be noted that write commands should not be set to variables or the Modbus register cyclically or repeatedly set to the same values. Permanent writing of values can cause damage to the device (memory).

Modbus Register BLU-SENTINEL PRO ELECTRONICS MODULE

IP address: IP address of the device, e.g. 192.168.200.12

Port: 502

MB Register	Description	Type	No. byte	Access	Max.	Min.	Description
[400001-400099] Info area							
400001	System name	ASCII	20	RD			e.g. "BLU-SENTINEL PRO"
400011	Software version	ASCII	10	RD			e.g. "V:1.31"
400016	Current date	ASCII	10	RD			e.g. "21.02.18"
400021	Current time	ASCII	6	RD			e.g. "13:16"

MB Register	Description	Type	No. byte	Access	Max.	Min.	Description
[400100-400299] Measurements (read only)							
(Ch.1) Chlor							
400100	Measured value	FLOAT	4	RD	-	Lower range	
400102	Measurement unit	ASCII	10	RD	-	-	mg/l
400107	Lower range	FLOAT	4	RD	-	-	
400109	Upper range	FLOAT	4	RD	-	-	
400111	Current setpoint	FLOAT	4	RD	Upper range	Lower range	Normal/Eco/Cedox Setpoint
400113	Current dosing rate/control value Yout	FLOAT	4	RD	100.0%	0.0%	
(Ch.2) pH							
400115	Measured value	FLOAT	4	RD	-	-	
400117	Measurement unit	ASCII	10	RD	-	-	pH
400122	Lower range	FLOAT	4	RD	-	-	
400124	Upper range	FLOAT	4	RD	-	-	
400126	Current setpoint	FLOAT	4	RD	Upper range	Lower range	
400128	Current dosing rate./control value Yout	FLOAT	4	RD	100.0%	0.0%	
(Ch.3) ORP							
400130	Measured value	FLOAT	4	RD	-	-	
400132	Measurement unit	ASCII	10	RD	-	-	mV
400137	Lower range	FLOAT	4	RD	-	-	
400139	Upper range	FLOAT	4	RD	-	-	
400141	-		4	RD			
400143	-		4	RD			
(Ch.4) Total chlorine							
400145	Measured value	FLOAT	4	RD	-	-	
400147	Measurement unit	ASCII	10	RD	-	-	mg/l
400152	Lower range	FLOAT	4	RD	-	-	
400154	Upper range	FLOAT	4	RD	-	-	
400156	Current setpoint	FLOAT	4	RD	Upper range	Lower range	
400158	Current dosing rate./control value Yout	FLOAT	4	RD	100.0%	0.0%	
(Ch.5) Conductivity							
400160	Measured value	FLOAT	4	RD	-	-	
400162	Measurement unit	ASCII	10	RD	-	-	µS/cm – mS/cm
400167	Lower range	FLOAT	4	RD	-	-	
400169	Upper range	FLOAT	4	RD	-	-	
400171	Current setpoint	FLOAT	4	RD	Upper range	Lower range	
400173	Current dosing rate/control value Yout	FLOAT	4	RD	100.0%	0.0%	
Temperature							
400175	Measured value	FLOAT	4	RD	+60.0°	-10.0°C	
400177	Measurement unit	ASCII	10	RD	-	-	°C/°F
400182	Lower range	FLOAT	4	RD	-	-	
400184	Upper range	FLOAT	4	RD	-	-	

MB Register	Description	Type	No. byte	Access	Max.	Min.	Description
Flocculation							
400190	Current dosing rate for flocculation	FLOAT	4	RD	100.0%	0.0%	
mA Input 1 Volume flow							
400205	Current volume flow	FLOAT	4	RD	Upper range	Lower range	mA Input 1
400207	Measurement unit	ASCII	10	RD	-	-	m ³ /h, %, ...
400212	Lower range	FLOAT	4	RD	-	-	
400214	Upper range	FLOAT	4	RD	-	-	
mA Input 2							
400220	Measured value	FLOAT	4	RD	Upper range	Lower range	mA Input 2
400222	Measurement unit	ASCII	10	RD	-	-	
400227	Lower range	FLOAT	4	RD	-	-	
400229	Upper range	FLOAT	4	RD	-	-	
[400300-400399] Status messages (read only)							
400300	Limit contact states	UINT16	2	RD			0x0001 - Limit contact 1 0x0002 - Limit contact 2 0x0004 - Limit contact 3 0x0008 - Limit contact 4 0x0010 - Limit contact 5 0x0020 - Limit contact 6 0x0040 - Limit contact 7 0x0080 - Limit contact 8
400301	Digital input	UINT16	2	RD			0x0001 - DI 1 0x0002 - DI 2 0x0004 - DI 3 0x0008 - Sample water stop (open=1, closed=0)
400302	Relay outputs K1..K8	UINT16	2	RD			0x0001 - Relay K1 0x0002 - Relay K2 0x0004 - Relay K3 0x0008 - Relay K4 0x0010 - Relay K5 0x0020 - Relay K6 0x0040 - Relay K7 0x0080 - Relay K8
400303	Relay outputs K21..K24	UINT16	2	RD			0x0001 - Relay K21 0x0002 - Relay K22 0x0004 - Relay K23 0x0008 - Relay K24
400304	Operation mode controller 1 (Chlorine)	UINT16	2	RD			0x0001 - Manual 0x0002 - Automatic 0x0004 - Controller off 0x0008 - Auto tune running 0x0010 - autom. positioner calibration active 0x0020 - Controller stop (Yout=0%) 0x0040 - Freeze controller (Yout=Yout) 0x0080 - Controller Yout=100% 0x0100 - Controller Yout=2xYout 0x0200 - Setting wheel on positioner unlocked 0x0400 - Positioner Poti error 0x0800 - Eco Mode switchover
400305	Operation mode controller 2 (pH)	UINT16	2	RD			Bit coding as for controller 1
400306	Operation mode controller 3 (ges. Chlor)	UINT16	2	RD			Bit coding as for controller 1

MB Register	Description	Type	No. byte	Access	Max.	Min.	Description
400307	Operation mode controller 4 (conductivity)	UINT16	2	RD			Bit coding as for controller 1
400308	Error code chlorine (Ch.1)	UINT32	4	RD			0x00000001 - Zero point calibration 0x00000002 - DPD calibration 0x00000004 - pH7 calibration 0x00000008 - pHX calibration 0x00000010 - Calibration error e.g. ORP 0x00000020 - Offset calibration 0x00000040 - -- 0x00000080 - Cell error 0x00000100 - Factory calibration error 0x00000200 - -- 0x00000400 - -- 0x00000800 - Setpoint error 0x00001000 - Limit value error 0x00002000 - Peak chlorination error (Cl2++) 0x00004000 - Combined chlorine error 0x00008000 - Overfeed (max. Dosing time) 0x00010000 - Auto tune error 0x00020000 - CAN communication 0x00040000 - Temperature error 0x00080000 - -- 0x00100000 - No sample water 0x00200000 - Positioner error 0x00400000 - Positioner calibration error 0x00800000 - mA output 1 Load error 0x01000000 - mA output 2 Load error 0x02000000 - mA output 3 Load error 0x04000000 - mA output 4 Load error 0x08000000 - Analog actuator error 0x10000000 - Flocculation error 0x20000000 - Peak chlorination error 0x40000000 - Analog hardware error 0x80000000 - Data storage error (SD/EEProm)
400310	Error code pH (Ch.2)	UINT32	4	RD			Bit coding as for error code chlorine
400312	Error code ORP (Ch.3)	UINT32	4	RD			Bit coding as for error code chlorine
400314	Error code total chlorine (Ch.4)	UINT32	4	RD			Bit coding as for error code chlorine
400316	Error code conductivity (Ch.5)	UINT32	4	RD			Bit coding as for error code chlorine
[401000-401049] Controller parameter (read and write)							
(Ch.1) Chlor							
401000	Setpoint (W)	FLOAT	4	RW	Upper range	Lower range	
401002	P-element (Xp)	FLOAT	4	RW	1000%	0%	
401004	I-element (Tn)	FLOAT	4	RW	100.0 min	0.0 min	0.0 min means Tn inactive
(Ch.2) pH							
401006	Setpoint (W)	FLOAT	4	RW	Upper range	Lower range	
401008	P-element (Xp)	FLOAT	4	RW	1000%	0%	
401010	I-element (Tn)	FLOAT	4	RW	100.0 min	0.0 min	0.0 min means Tn inactive
(Ch.4) CLN							
401012	Setpoint (W)	FLOAT	4	RW	Upper range	Lower range	
401014	P-element (Xp)	FLOAT	4	RW	1000%	0%	
401016	I-element (Tn)	FLOAT	4	RW	100.0 min	0.0 min	0.0 min means Tn inactive

MB Register	Description	Type	No. byte	Access	Max.	Min.	Description
(Ch.5) Conductivity							
401018	Setpoint (W)	FLOAT	4	RW	Upper range	Lower range	
401020	P-element (Xp)	FLOAT	4	RW	1000%	0%	
401022	I-element (Tn)	FLOAT	4	RW	100.0 min	0.0 min	0.0 min means Tn inactive
[401050-401149] Limit value parameters (read and write)							
(Ch.1) Chlorine							
401050	Min. value 1	FLOAT	4	RW	Max. value 1	Lower range	mg/l
401052	Max. value 1	FLOAT	4	RW	Upper range	Min. Wert 1	
401054	Hysteresis value 1	FLOAT	4	RW	25 Digit	1 Digit	
401056	Min. value 2	FLOAT	4	RW	Max. value 2	Lower range	
401058	Max. value 2	FLOAT	4	RW	Upper range	Min. value 2	
401060	Hysteresis value 2	FLOAT	4	RW	25 digit	1 digit	
(Ch.2) pH							
401062	Min. value 1	FLOAT	4	RW	Max. value 1	Lower range	pH
401064	Max. value 1	FLOAT	4	RW	Upper range	Min. value 1	
401066	Hysteresis value 1	FLOAT	4	RW	25 Digit	1 Digit	
401068	Min. value 2	FLOAT	4	RW	Max. value 2	Lower range	
401070	Max. value 2	FLOAT	4	RW	Upper range	Min. value 2	
401072	Hysteresis value 2	FLOAT	4	RW	25 digit	1 digit	
(Ch.3) ORP							
401074	Min. value 1	FLOAT	4	RW	Max. value 1	Lower range	mV
401076	Max. value 1	FLOAT	4	RW	Upper range	Min. value 1	
401078	Hysteresis value 1	FLOAT	4	RW	25 Digit	1 Digit	
401080	Min. value 2	FLOAT	4	RW	Max. value 2	Lower range	
401082	Max. value 2	FLOAT	4	RW	Upper range	Min. value 2	
401084	Hysteresis value 2	FLOAT	4	RW	25 digit	1 digit	
(Ch.4) CLN							
401086	Min. value 1	FLOAT	4	RW	Max. value 1	Lower range	mg/l
401088	Max. value 1	FLOAT	4	RW	Upper range	Min. value 1	
401090	Hysteresis value 1	FLOAT	4	RW	25 digit	1 digit	
401092	Min. value 2	FLOAT	4	RW	Max. value 2	Lower range	
401094	Max. value 2	FLOAT	4	RW	Upper range	Min. value 2	
401096	Hysteresis value 2	FLOAT	4	RW	25 digit	1 digit	
(Ch.5) Conductivity							
401098	Min. value 1	FLOAT	4	RW	Max. value 1	Lower range	µS/cm – mS/cm
401100	Max. value 1	FLOAT	4	RW	Upper range	Min. value 1	
401102	Hysteresis value 1	FLOAT	4	RW	25 digit	1 digit	
401104	Min. value 2	FLOAT	4	RW	Max. value 2	Lower range	
401106	Max. value 2	FLOAT	4	RW	Upper range	Min. value 2	
401108	Hysteresis value 2	FLOAT	4	RW	25 digit	1 digit	
Temperature							
401110	Min. value 1	FLOAT	4	RW	Max. value 1	Lower range	°C
401112	Max. value 1	FLOAT	4	RW	Upper range	Min. value 1	
401114	Hysteresis value 2	FLOAT	4	RW	25 digit	1 digit	

5. Installation

5.1 Scope of supply

The Blu-Sentinel™ Pro electronics module is supplied with the following:

- Blu-Sentinel™ Pro electronics module (module type E01)
- Din rail
- Assembly accessories
- 4-way mA analog output
- Instruction manual Blu-Sentinel™ Pro electronics module

Additional includes the scope of supply:

- Blu-Sentinel™ Pro flow cell pressurized version (module type D01)
- LED glow stick
- Free chlorine sensor
- pH electrode (yellow)
- ORP electrode (blue)
- Strainer with ball valve
- Instruction manual Blu-Sentinel™ Pro flow cell

Optional accessories:

- Conductivity sensor
- SiDiSens conductivity module
- Total chlorine membrane sensor TC3 CAN

5.2 Transport and storage

Transport The Blu-Sentinel™ Pro electronics module is supplied in standard packaging. During transport, the packaged system must be handled carefully and should not be exposed to wet weather or moisture.

Check that the transport packaging is undamaged. In the event of damage, please inform the transport company immediately, as your rights to compensation will otherwise be lost.

If a component is damaged, please contact your affiliate immediately.

Keep the packaging until the Blu-Sentinel™ Pro electronics module has been correctly installed and taken into operation.

Storage Store the Blu-Sentinel™ Pro electronics module, the Blu-Sentinel™ Pro flow cell and the sensors in a dry condition without any residual water in a dry place that is not exposed to the weather. Storage temperature, see Chapter 3.5 “Technical Data electronics module (module type E01)”.

5.3 Requirements for the ambient conditions

NOTICE

Correct and safe operation can only be guaranteed if the requirements for the ambient conditions are met. All applicable national and local regulations must be observed!

5.3.1 Installation site

The following points must be taken into account when installing the Blu-Sentinel™ Pro electronics module:

- The Blu-Sentinel™ Pro electronics module must be protected from moisture, rain, frost, heat and direct sunlight and must not be installed outdoors.
- Do not use the Blu-Sentinel™ Pro electronics module in environments where there are flammable gases, fumes or dust or conductive dust.
- Do not subject the Blu-Sentinel™ Pro electronics module to strong shocks or vibrations.
- The air in the room should be non-condensing.

5.4 Mechanical installation

NOTICE

The Pool Management System is comprised of the Blu-Sentinel™ Pro flow cell and the Blu-Sentinel™ Pro electronics module. We recommend joint assembly of the modules. Leave a clearance of at least 10 inches above the Pool Management System for working with the sensors.



⚠ WARNING

Risk of injury or damage to the installation!

All electrical work on the equipment must be performed only by authorized and qualified electricians. Modifications to the device other than those described in this instruction manual are not permitted.

The following installation options are available to mount the Blu-Sentinel™ Pro flow cell and Blu-Sentinel™ Pro electronics module:

- with din rail
 - without din rail
-

NOTICE

The Blu-Sentinel™ Pro electronics module is not suitable for electrical connection with permanently installed cable conduits. If the cable glands do not meet local installation rules and regulations, these glands must be replaced with suitable ones.

5.4.1 Installation variant with din rail

Proceed as follows, see Chapter 5.4.3 “Dimension Drawing”:

- 1 Secure the din rail to a solid wall using the supplied dowels and screws. (screws and dowels for fixing to a solid wall are included in the scope of supply.)

NOTICE

If the device is to be installed on a suitable lightweight wall, use the relevant mounting fixtures (not included in the scope of supply).

- 2 Hook the Blu-Sentinel™ Pro electronics module onto the din rail so that it is flush at the right.
- 3 Fasten the Blu-Sentinel™ Pro electronics module to the solid wall at the bottom by the holders using dowels and screws.
- 4 Hook the Blu-Sentinel™ Pro flow cell onto the din rail on the left next to Blu-Sentinel™ Pro electronics module.
- 5 Fasten the Blu-Sentinel™ Pro flow cell to the solid wall at the bottom by the holders using dowels and screws.

5.4.2 Installation variant without din rail

Instead of hooking the Blu-Sentinel™ Pro flow cell and the Blu-Sentinel™ Pro electronics module onto the din rail, they can also be hooked onto suitable tallow-drop screws by the top holding clips.

NOTICE

The dimensions for the drilling pattern can be found on the back of the plastic housing.

Proceed as follows:

- 1 Affix the supplied screws and dowels to the solid wall (screws and dowels for fixing to a solid wall are included in the scope of supply.)

NOTICE

If the device is to be installed on a suitable lightweight wall, use the relevant mounting fixtures (not included in the scope of supply).

- 2 Hook the Blu-Sentinel™ Pro electronics module into the screws.
- 3 Fasten the Blu-Sentinel™ Pro electronics module to the solid wall at the bottom by the holders using dowels and screws.
- 4 Hook Blu-Sentinel™ Pro flow cell into screws.
- 5 Fasten the Blu-Sentinel™ Pro flow cell to the solid wall at the bottom by the holders using dowels and screws.

NOTICE

If the Blu-Sentinel™ Pro electronics module and Blu-Sentinel™ Pro flow cell are mounted at separate locations, you must use CAN cable extensions (optional). The length of 1000 m must not be exceeded.

5.5 Electrical installation

⚠ DANGER**Risk of injury or death!**

External voltages may be connected even with the operating voltage switched off. Disconnect all power sources before opening the Blu-Sentinel™ Pro electronics module.

⚠ CAUTION

Controller power and pump power must be separated. This setup reduces noise inside the controller and eliminates controller damage due to transient spikes from the pumps. It also allows pump power to be interrupted without interrupting controller power.

**⚠ WARNING****Risk of injury or damage to the device!**

Only authorized and qualified electricians are permitted to install the Blu-Sentinel™ Pro electronics module and open the housing. The Blu-Sentinel™ Pro electronics module may only be put into operation when the housing is closed, and must be connected to earth ground. Modifications other than those described in this manual are not permitted.

Only wire the Blu-Sentinel™ Pro electronics module when it is disconnected from the mains power. Connect the Blu-Sentinel™ Pro electronics module in accordance with the wiring diagrams and applicable national and local regulations.

**WARNING****Risk of injury or damage to the device!**

The Blu-Sentinel™ Pro electronics module is not equipped with a mains switch and is in operation as soon as the supply voltage is applied. An external switch or circuit breaker with a clearly visible "OFF" switch position is therefore necessary.

When a local line fuse is used (6 A) at 100 to 240 V AC supply, the cross-section of the mains cable must be at least 0.75 mm² (AWG 18).

When connecting system components (e.g. devices, motors, pumps) as well as when entering operating data, the system components must be switched off in order to prevent uncontrolled activation or any incorrect operation.

Installations with internal supplied loads (e.g. dosing machines) or models with fixed installed connection wires (plug connection) must not have a current consumption higher than 6 A.

NOTICE

The Blu-Sentinel™ Pro electronics module is not suitable for electrical connection with permanently installed cable conduits. If the cable glands do not meet local installation rules and regulations, these glands must be replaced with suitable ones.

**WARNING****Electrical hazard!**

Risk of electrical shock.

Line voltage (120/240VAC) can be present inside the Blu-Sentinel™ Pro electronics module and caution should be used to prevent electrical shock, burns or electrocution. Be sure electric power is disconnected before opening the cover of any Blu-Sentinel™ electronics module. Follow all local safety policies, procedures and electrical codes, to prevent injury from electrical hazards, before opening the cover of this controller. If you are not trained and comfortable performing work on electrical equipment, contact a licensed electrician to perform the work.

**⚠ WARNING****Risk of injury or damage to the device!**

High temperatures at the terminals of the relay and the power supply!

The terminals may become very hot with high ambient temperatures and the connected cables must be designed to withstand these temperatures.

Ambient temperature <30°C:
cable temperature resistant up to at least 60°C

Ambient temperature <40°C:
cable temperature resistant up to at least 70°C

Ambient temperature >40°C:
cable temperature resistant up to at least 80°C

⚠ CAUTION**Risk of electrical shock!**

To ensure safe and correct commissioning, knowledge of the operation, connected electrical load, measurement signals, cable assignment and fuse protection of the connected devices and machines and the relevant safety regulations is required.

Start-up of the Blu-Sentinel™ Pro electronics module may therefore only be performed by qualified and authorized electricians.

Incorrectly connected systems can be damaged, possibly irreparably, or cause faults in other equipment when they are switched on or in operation. Ensure that the measuring and control cables are not confused or make contact with one another. Never connect or disconnect any cables to which voltage is applied.

**⚠ WARNING****Risk of injury or damage to the device!**

Only wire the Blu-Sentinel™ Pro electronics module when it is disconnected from the mains.

The Blu-Sentinel™ Pro electronics module is equipped with a variable voltage supply input and accepts AC voltages from 100 to 240 Volt and 24 V DC. When dimensioning, take into account the power consumption. Refer to Chapter 3.5 "Technical Data electronics module (module type E01)".



⚠ WARNING**Electrical surges can damage your controller!**

A damaged controller could feed chemicals in an uncontrolled manor.

Uncontrolled feeding of chemicals can result in injury or death. If you suspect your controller is not operating properly, disconnect it from control of chemical feed.

Blu-Sentinel™ Pro electronics module, like all modern electronic devices can be damaged by severe electrical spikes and surges (think 'lightning'). Every effort has been made to protect your Blu-Sentinel™ Pro electronics module against such surges, but no precautions are 100% effective. Additional surge protection can be installed at time of installation, but even that is not a guarantee that surge damage will not occur. If surge damage occurs, chemicals could be fed to your pool or spa, continuously with no safety controls. If you inspect your Blu-Sentinel™ Pro after a possibly damaging power surge (thunderstorm or power outage) and suspect the controller is not operating properly, disconnect the chemical feeders at once, and contact your Blu-Sentinel™ Pro dealer for service.



⚠ WARNING**Always use anti-siphon devices!**

Uncontrolled feeding of chemicals can result in injury or death. Anti-siphon devices must be installed to prevent uncontrolled chemicalfeed. Follow instructions carefully.

If a vacuum is created in the water circulation line and no anti-siphon device is installed on the chemical feeders, potentially hazardous concentrations of chemicals can be drawn into pool or spa. Always use injection check valves and anti-siphon valves in the chemical feed lines to prevent this situation from occurring.

**⚠ WARNING****Test flow switch function!**

Uncontrolled feeding of chemicals can result in injury or death. Assure flow switch prevents chemical feed in any circulation NO-FLOW or backwash condition. Follow instructions carefully.

If flow switch does not stop and remain stopped during backflow, no-flow, or very low flow conditions, the controller cannot prevent the uncontrolled feed of chemicals, which could cause personal injury or death.

Testing of the flow switch installation is essential to assure the flow switch stops, remains stopped, and controller shows "NO-FLOW ALARM" within 20 seconds, whenever pool circulation flow stops. If the flow switch does not stop completely, plumbing corrections or the installation of additional safeguards will be necessary to avoid uncontrolled chemical feed.

**⚠ WARNING****Never connect feeder directly to power source!**

Uncontrolled feeding of chemicals can result in injury or death. Chemical metering pumps must be interconnected to the controller to enable safety controls. Follow instructions carefully.

If the chemical feeders are directly connected to a wall outlet, the safety devices integral to your Blu-Sentinel™ Pro electronics module, and to the safe feeding of chemicals, will be bypassed. It is very important that the chemical feeders are connected to the controller and never to a wall outlet. If the chemical feeders are connected to a wall outlet and feeding continuously, when the flow of water to the pool stops due to filter backwash, the circulation pump losing prime or other causes, potentially hazardous concentrations of chemicals can be fed into pool or spa.



⚠ WARNING

Always install a recirculation pump interlock!

Chemical feed without water circulation can result in injury or death.

Circulation pump interlock with chemical feeders is a critical safety device which prevents unsafe chemical feed.

Recirculation pump must be interlocked to prevent chemical feed whenever pump power is removed. Follow instructions carefully.

If concentrated Chlorine and Acid are combined, chlorine gas is released. Chlorine gas causes severe irritation to lungs and can be toxic in certain situations.

If water is not flowing in the return line piping to the pool, and both these concentrated chemicals are allowed to combine in the piping, a chlorine gas bubble will be created. When the flow eventually resumes to the pool, the chlorine bubble would then be flushed into the pool and released into the air around the pool, beginning at the water surface. To help prevent this situation, a chemical pump interlock must be installed. An interlock removes power from the chemical feed pumps whenever the power to the recirculation pump power is switched off.

Electrical Installation

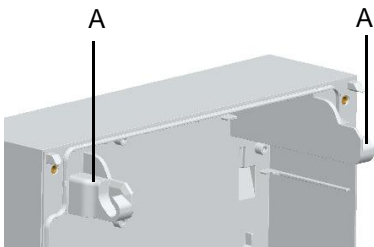

Proceed as follows:

- 1 Open the housing cover of the Blu-Sentinel™ Pro electronics module. To do so, unscrew the housing cover and hook into the holders (A) on the base housing.
- 2 Connect the power supply in accordance with the wiring diagram (see Chapter 9. "Wiring Diagrams").

NOTICE

Note the correct polarity of the voltage connections and the correct dimensioning of the wire gage (see "Chapter 3.5 "Technical Data electronics module (module type E01)"" – Power consumption).

- 3 Wire the A&C-Board in accordance with wiring diagram Chapter 9. "Wiring Diagrams".
- 4 Make sure that all cable glands are installed correctly.
- 5 Refit the housing cover of the Blu-Sentinel™ Pro electronics module. Tighten the housing screws to a maximum torque of 0.7 Nm (± 0.15 Nm).
- 6 Install CAN connection cable to the Blu-Sentinel™ Pro flow cell and Blu-Sentinel™ Pro electronics module (see Chapter 4.1 "CAN interface").
- 7 Then switch on the Blu-Sentinel™ Pro electronics module. See Chapter 5.6 "Commissioning".

5.6 Commissioning

After the Blu-Sentinel™ Pro electronics module and the Blu-Sentinel™ Pro flow cell are installed, you can perform the first commissioning. See also the corresponding instruction manuals of the Blu-Sentinel™ Pro flow cell and sensors.

Please check if the following conditions are met:

- Blu-Sentinel™ Pro electronics module electrically wired according to the wiring diagram (circuit diagram).
- Housing cover of the Blu-Sentinel™ Pro electronics module fitted.
- Blu-Sentinel™ Pro flow cell installed.
- Sample water inlet and outlet connected.
- Blu-Sentinel™ Pro flow cell equipped with sensors.
- CAN connection cable installed.



⚠ WARNING

Risk of injury or damage to the device!

When connecting the Blu-Sentinel™ Pro electronics module to the power supply, a 6A back-up fuse must be used in the main supply line.

Proceed as follows:

Ser. No.	Procedure	Completed
1	Switch on power supply.	
2	Perform initial configuration: <ul style="list-style-type: none"> • Set "MANUAL" mode • Select the language • Set the date and time. • Enter the system name • Select measurements 	
3	Set the controller mode.	
4	Set control output for Cl ₂ , if necessary set positioner running time "Ty" or "max.pulses/min", only applicable with gas feed equipment.	
5	Calibrate "Ym" on positioner with feedback, only applicable with gas feed equipment.	

Ser. No.	Procedure	Completed
6	Check setpoint for Cl ₂ control, change if necessary (only for Cl ₂ single feedback closed loop control).	
7	Adapt values for "Xp" and "Tn" to control loop. NOTICE These values may be optimized later by adaption or manually.	
8	If a dosing pump is used, check the "Tp" parameter and adapt to the pump, if necessary	
9	If ECONOMIC mode used, check "Cl2 parameter ECO", change if necessary.	
10	Check limit values for Cl ₂ ("min" and "max"), adjust if necessary	
11	For CEDOX: Check min. setpoint and max. setpoint, change if necessary.	
12	Check setpoint for Cl ₂ control, adjust, if necessary	
13	Set the peak chlorination parameters, if required.	
pH measurement (if available)		
14	Set the dosing output for pH, if necessary, set positioner running time "Ty", "Xsh" or "max. pulses/min".	
15	Set the control direction (for pumps or analog output).	
16	Check the setpoint for pH control, adjust if necessary	
17	Adapt the values for "Xp" and "Tn" to the control loop, if necessary optimize in small steps.	
18	If a dosing pump is used, check the "Tp" parameter and adapt to the pump, if necessary	
19	Check the limit values for pH ("min" and "max"), adjust if necessary.	
Flocculation control (if used)		
20	Check the limit values for flocculation control "Flocc. (min)" and "Flocc. (max)". NOTICE These values must be obtained from the flocculant manufacturer or are mentioned on the flocculant tank.	
21	Check the measurement range for pH, adjust if necessary.	

Ser. No.	Procedure	Completed
ORP measurement		
22	For controller mode CEDOX: Set ORP setpoint, if necessary set ORP setpoint _{ECO} , check X _{sh} , change if necessary. Check the ORP delay time, adjust if necessary.	
23	Check the limit values for ORP ("min" and "max"), adjust if necessary.	
24	Check the measurement range for ORP, adjust if necessary.	
Combined chlorine (if a total chlorine sensor is installed)		
25	Check "max. comb. chlor", adjust if necessary.	
26	Check the "min ON" and "min OFF" times of the enable contact for activated powder carbon dosing systems or UV systems, adjust if necessary.	
27	Check the limit values for combined chlorine ("min" and "max"), adjust if necessary.	
28	Check the measurement range for combined chlorine, adjust if necessary.	
Conductivity measurement (if available)		
29	Set the dosing output for conductivity, set "max pulses/min" if necessary.	
30	Set the control direction	
31	Check the setpoint for conductivity control, adjust if necessary.	
32	Adapt the value for "Xp" to the control loop, if necessary optimize in small steps.	
33	If a dosing pump is used, check the "Tp" parameter and adapt to the pump, if necessary.	
34	Check the limit values for conductivity ("min" and "max"), adjust if necessary.	
35	Check the measurement range for conductivity, adjust if necessary.	
36	Check the unit of the "NaCl display", change if necessary.	

5.7 Shutting down

⚠ DANGER**Risk of injury or death!**

External voltages may be connected even with the operating voltage switched off. Disconnect all power sources before opening the Blu-Sentinel™ Pro electronics module.

To shut down, proceed as follows:

- 1 Disconnect the Blu-Sentinel™ Pro electronics module from the power supply.
- 2 Switch off the Blu-Sentinel™ Pro flow cell and sensors. See the corresponding instruction manuals of the Blu-Sentinel™ Pro flow cell and sensors.

5.8 Renewed start up

Refer to Chapter 5.6 "Commissioning".

6. Operation

6.1 Display and control elements

The color graphic display with resistive touch panel is the display and control element. It is used by means of direct entry on the display or by touching using your finger or a pen (PDA pen) for touch-screens. As soon as you touch an area on the display, the Blu-Sentinel™ Pro electronics module reacts and switches to subordinate views or operating menus.

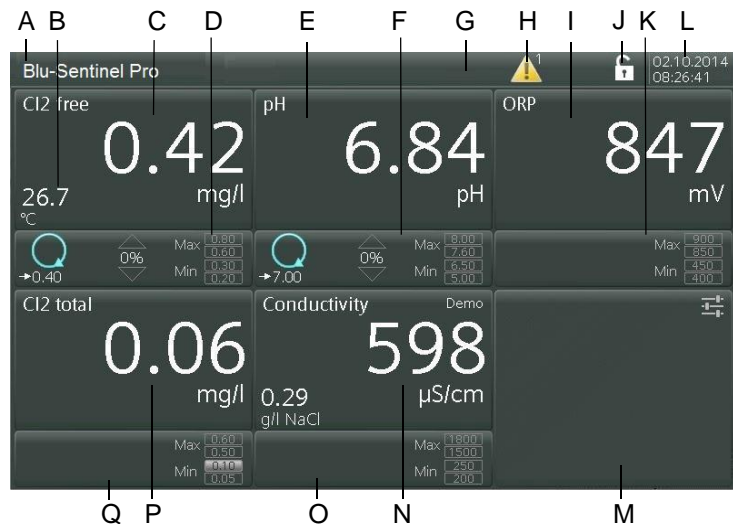





















Image 1 Main screen (example)

- A Name of the Pool Management system
- B Current pool water temperature
- C Menu field Free chlorine measurement with current measuring value
- D Menu field Chlorine adjustment with display of operation mode and limit values
- E Menu field pH-measurement with current measuring value
- F Menu field pH-control with display of operation mode and limit value
- G Menu field System
- H Symbol for error message with number to show the number of error messages
- I Menu field ORP measurement with current measuring value
- J Password symbol
- K Menu field ORP control with display of limit values
- L Current date and time
- M Menu field Inputs and outputs
- N Menu field Conductivity measurement with current measuring value (optional)
- O Menu field Conductivity control with display of operation mode and limit values (optional)
- P Menu field Total chlorine measurement with current measuring value (alternative combined chlorine with current calculated value)
- Q Menu field Total chlorine control with display of operation mode and limit values

Display/symbols	Explanation
	Every available main measurement is displayed in a specific display area (menu field) in the display. The menu field shows: <ul style="list-style-type: none"> • the sensor type (e.g. Cl2 free) • the unit (e.g. mg/l or ppm) • the temperature and unit (for the chlorine value only)
	Operating mode Auto with setpoint display
	Operation mode Manual
	Displays the dosing output of the controller as a percentage Arrow up = increase output to reach setpoint Arrow down = decrease output to reach setpoint
	Displays the limit values Max I and Max II as well as Min I and Min II
	Switch to the previous screen
	Switch to the next screen
	Home key (main view)
	Button to open the message window, e.g. for error messages, exceedance of limit values, etc.
	System bar with customer-specific configurable system names. Depending on the status of the messages, it appears in a different color: <ul style="list-style-type: none"> • white-blue: all OK • yellow-green: warnings present • red: Faults
	Displays the date and time

Display/symbols	Explanation
	User has logged in with password To protect against unauthorized or accidental incorrect operation, the Blu-Sentinel™ Pro electronics module works with two password levels: <ul style="list-style-type: none"> • System password allows full access to all setting options and display of all menus • Calibration password allows access for calibration purposes and to display all menus The password consists of multi-digit customer-specific number combinations with a minimum of 3 and a maximum of 24 digits.
	ECO mode active - only used with gas feed equipment
	Controller STOP
	Controller output constant
	Controller 100 %
	Pos. motor calibration active - only used with gas feed equipment
	Automatic adaption active
	Super chlorination active
	Double controller output

Explanation of the buttons:

Input field	For text/value entry.
Selection field	If a selection is listed.
Option field	If an option can be selected.

General messages:

Invalid entry	Incorrect entry, is ignored by the system
---------------	---

6.2 Menus

The following menus are available:

- free chlorine
- pH
- ORP
- Total chlorine or optional combined chlorine
- Conductivity (optional)
- Inputs / outputs
- System

The layout of the measurement and control menus for Free chlorine, pH, ORP, Total chlorine or Optional combined chlorine and Conductivity is the same. If all sensors are connected, the following basic screen appears on the Blu-Sentinel™ Pro electronics module:

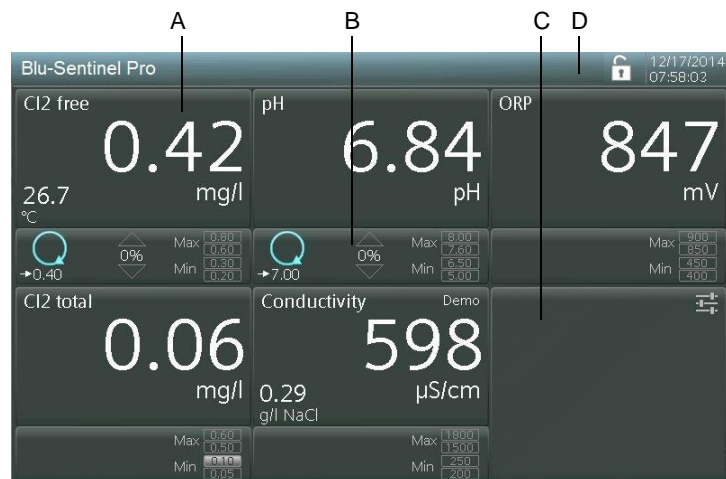

- A Menu field Measurement with current measuring value*
B Menu field Control with display of operation mode and limit values
C Menu field Inputs and outputs
D Menu field System

From the basic screen, you can call up the measurements, controls and system settings.

6.2.1 Measurements

The measurement is taken from the example “Free chlorine”.

Proceed as follows:

- 1 Call up the basic screen.
- 2 Press the menu field „Measurement with current measuring value (Cl2 free)”.
- 3 The screen changes to the menu “Cl2 free - Measurement”.

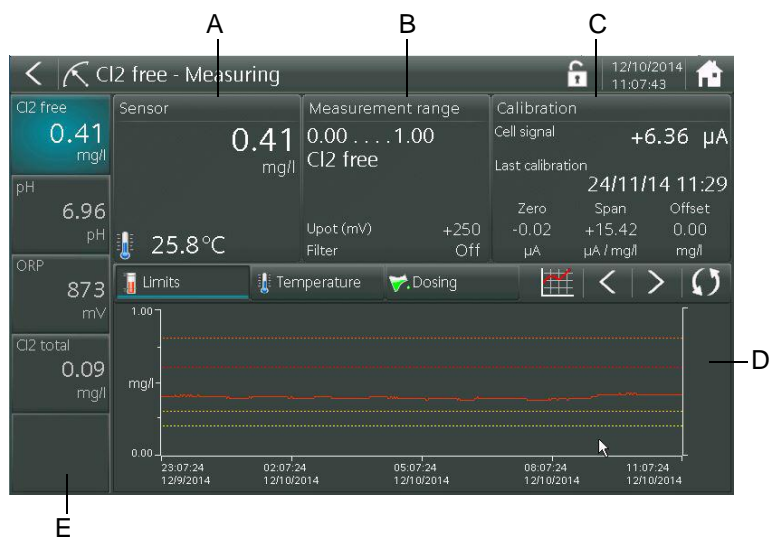

This display gives the option to switch to subordinate menu fields:

- Sensor (A)
- Measurement range (B)
- Calibration (C)
- Trend analysis (D)
 - Limit values
 - Temperature
 - Dosing
 - Trend diagram
 - Scroll forward or back
 - Update
- Parameter keys for quick selection (E)

- 4 Select the corresponding menu fields.

Selecting the menu fields

The following menu fields can be selected:

Menu field Sensor



The menu field „Sensor” shows the current measuring value for chlorine with unit. The current sample water temperature is displayed underneath with a temperature symbol.

- 1 Press the menu field „Sensor”.
- 2 The screen changes to the menu view “Diagnosis - module Cl2 free”. Only one view is possible. For explanation of screen, see “Diagnostics” on page 120.

Menu field Measurement range



The menu field „Measurement range” shows the currently set measurement range for chlorine and the selected sensor type. The selected potential voltage Upot and the set measuring value filter are also shown.

- 1 Press the menu field „Measurement range”.
- 2 The screen switches to the menu “Cl2 free - Measurement range”.
- 3 Select the desired input fields. The selection option is shown or the keypad appears.
- 4 Select or define the values.

NOTICE

Enter the corresponding values depending on the desired measurement.

Cl2 free-Measurement

Measurement range	0 to 1 mg/l to 0 to 20 mg/l
Unit	mg/l, ppm
Sensor type	Cl2 free, freely definable
Sensor type def.	Freely programmable sensor type which can be selected in the menu Sensor type. Example: Bromine
Measuring value filter	Off, low, middle, strong
Upot	0 to 1000 mV
µA measurement range	10, 100, 1000 µA
Select temp.	Cl2 free, A&C Board intern, Off

pH Measurement

Measurement range	
Start	0.00 to 6.00 pH
End	8.00 to 14.00 pH
Measuring value filter	Off, low, middle, strong

ORP measurement

Measurement range	
Start	000 to 700 mV
End	300 to 1000 mV
Measuring value filter	Off, low, middle, strong

Cl2 total measurement

Measurement range	1.00/2.00/5.00/10.0 mg/l
Unit	mg/l/ppm
Sensor type	Cl total2, Cl2 combined
Measuring value filter	Off, low, middle, strong

Conductivity measurement

Measurement range	500 $\mu\text{S/cm}$ / 2500 $\mu\text{S/cm}$ 10.00 mS/cm / 20.0 mS/cm/ 50.0 mS/cm / 100.0 mS/cm 200.0 mS/cm / 300.0 mS/cm
Unit	$\mu\text{S/cm}$ / mS/cm
Measuring value filter	Off, low, middle, strong
Reference temperature	20/25°C
Display	Off/NaCl(g/l)/NaCl(%)/TDS
Factor TDS	0.40 to 1.00

Menu field Calibration

Calibration		
Cell signal	+6.33 μA	
Last calibration	24/11/14 11:29	
Zero	Span	Offset
-0.02	+15.42	0.00
μA	$\mu\text{A} / \text{mg/l}$	mg/l

The menu field „Calibration” shows the current sensor signal of the chlorine measurement cell in μA , the date of the last calibration and the μA values saved at the last calibration for Zero point and Span.

- 1 Press the menu field „Calibration”.
- 2 The screen switches to the menu “Cl₂ free - Calibration”.
- 3 Select and define the desired control panels for calibrating the chlorine sensor. The keypad appears. See also Chapter 6.3 “Calibration”.

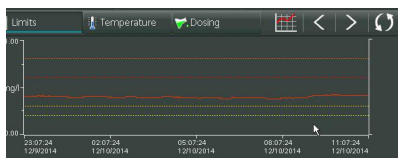
Menu field Trend analysis

The menu field „Trend analysis” shows the measuring value sequence of the free chlorine measurement over the past hours/ days.

The following buttons can be opened in the menu field Trend analysis:



- Limit values button
The button shows the limit values in the Cl₂ trend diagram.



- Temperature button
The button shows the temperature in the Cl₂ trend diagram.
- Dosing button

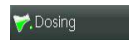

The button shows the dosing performance process in the Cl₂ trend diagram.



- Scroll forward or back button

Button to scroll forward or back in the trend diagram. With a sample rate of two minutes, the values can be traced approx. 60 days.



- Update button

Button to switch to the current time/day in the trend diagram.



- Trend diagram button

The button shows the measuring value sequence in the past and the temperature, dosing quantity and limit values as an option.

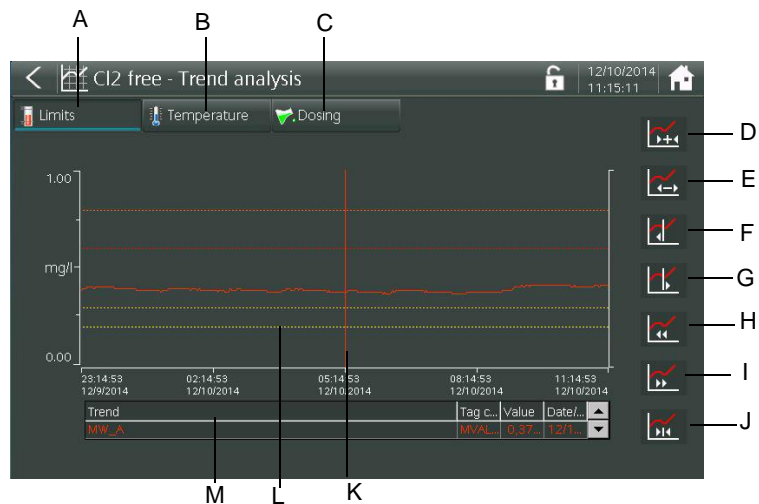

Image 2 Menu view example Cl₂ free

- A "Limit values" button to display the limit values in the Trend diagram
- B "Temperature" button to display the temperature course in the Trend diagram
- C "Dosing" button to display the dosing performance process in the trend diagram
- D Condensing of the trend screen by 12 hours, maximal four days is possible into one screen
- E Expansion of the time grid of the trend screen, max. 1.5 hours into one screen is possible
- F Move ruler to the left
- G Move ruler to the right
- H Scroll back through trend diagram
- I Scroll forward through trend diagram
- J Jump back to current time with current timescale
- K Ruler to move.
The measuring values saved on the ruler are displayed as a numerical value in the table under the diagram
- L Scaling of measurement range
- M Scaling of the dosing performance or temperature

6.2.2 Control

Controls are set from the example “Free chlorine”.

Proceed as follows:

- 1 Call up the basic screen.
- 2 Press the menu field „Free chlorine control with display of operation mode and limit values”.
- 3 The screen changes to the menu “Cl2 free - Control”.

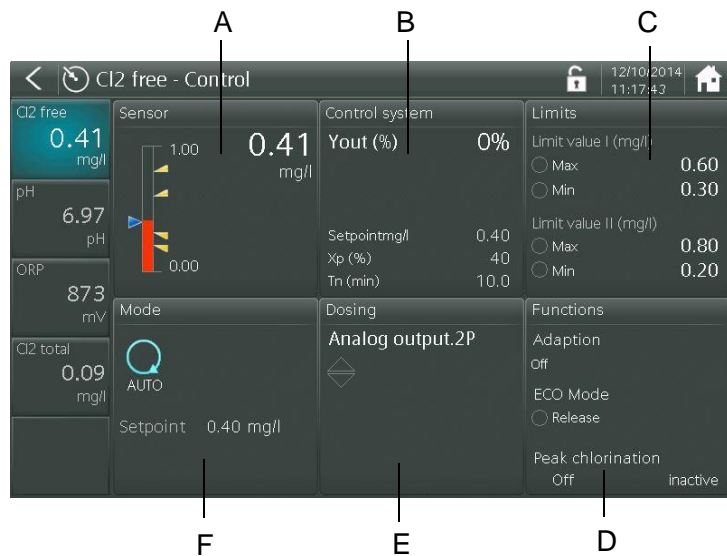

This screen offers the option to switch to subordinate menus.

- Sensor (A)
- Control (B)
- Limit values (C)
- Functions (D)
- Dosing (E)
- Operation mode (F)

- 4 Select the corresponding menu fields.

Selecting the menu fields

The following menu fields can be selected:

Menu field Sensor

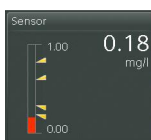

The menu field „Sensor” shows the current measured value with display of bargraph, the current setpoint (blue arrow) and the set minimum and maximum limit values (yellow arrows). The sensor view is not adjustable.

Menu field Control

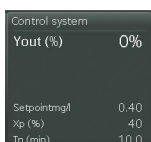

1 Press the menu field „Control”.

2 The display switches to the module-specific screen for the controller settings.

Depending on the module type selected, the different settings menus are displayed.

In this example, the menus of “Cl2 free - Controller setting” are displayed.

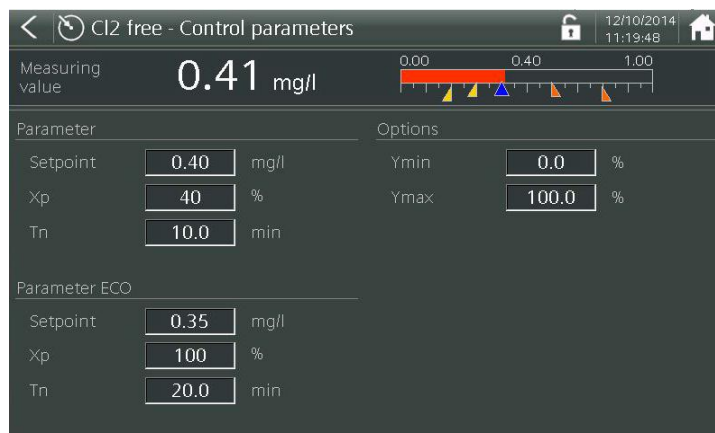

3 Select the desired input fields. The keypad appears.

4 Perform the controller settings.

The following controller settings can be realized:

Cl₂ free Controller setting

Parameter	
Setpoint	0.10 mg/l to end of the measurement range
Xp	0001 to 1000 %
Tn	000.0 to 100.0 min
Hysteresis	0.01 to 0.5 mg/l
min. ON	for dosing contact: 1 to 59 min.

NOTICE

To be within NSF compliance do not set the Tn parameter to 0 minutes to ensure that the controller will integrate to 100 % to activate the overfeed timer.

ECO parameter	
Setpoint _{ECO}	0.10 mg/l to end of the measurement range
Xp _{ECO}	0001 to 1000 %
Tn _{ECO}	000.0 to 100.0 min

NOTICE

To be within NSF compliance do not set the Tn parameter to 0 minutes to ensure that the controller will integrate to 100 % to activate the overfeed timer.

Control range options	
Ymin	0.0 to 100.0 %
Ymax	0.0 to 100.0 %

pH controller setting

Parameter	
Setpoint	within measurement range
Xp	0.0 to 100.0 %
Tn	000.0 to 100.0 min

NOTICE

To be within NSF compliance do not set the Tn parameter to 0 minutes to ensure that the controller will integrate to 100 % to activate the overfeed timer.

Options Control range	
Ymin	0.0 to 100.0 %
Ymax	0.0 to 100.0 %

Cl total - controller setting

Parameter	
Setpoint	within measurement range
Xp	0001 to 1000 %
Tn	000.0 to 100.0 min.

Conductivity-controller setting

Parameter	
Setpoint	within measurement range
Xp	0001 to 1000 %
Tn	000.0 to 100.0 min.

Limits	
Limit value I (mg/l)	
○ Max	0.60
○ Min	0.30
Limit value II (mg/l)	
○ Max	0.80
○ Min	0.20

Menu field Limit values

- 1 Press the menu field „Limit values“.
- 2 The screen changes to the menu “Cl2 free – Limit values”.

In this example, the settings menus are displayed for the limit values of Cl2 free Measurement.

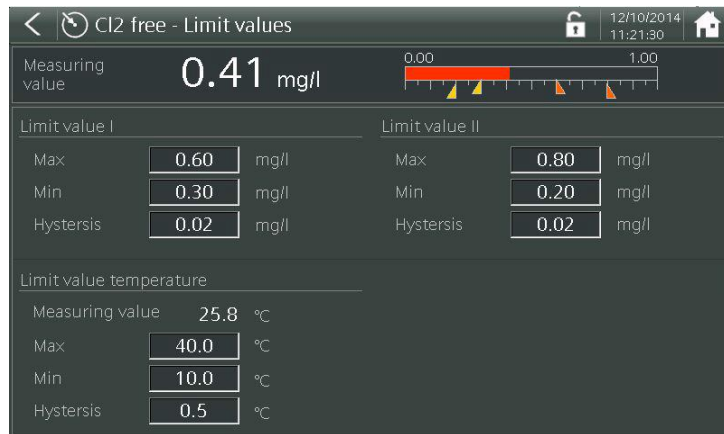

- 3 Select the desired input fields. The keypad appears.
- 4 Set the limit values.

The following limit value settings can be realized:

Two limit value channels (I and II) with a Min. and Max. setting value are available for each module. Each limit value channel also has a switching hysteresis that can be set.

Limit value I	
Max	within measurement range
Min	within measurement range
Hysteresis	Dependent on the measuring range 0.01 to 0.25 / 00.1 to 02.5

Limit value II	
Max	within measurement range
Min	within measurement range
Hysteresis	Dependent on the measuring range 0.01 to 0.25 / 00.1 to 02.5



Menu field Operation mode

- 1 Press the menu field „Operation mode“.
- 2 The screen changes to the menu “Cl2 - Operation mode”.

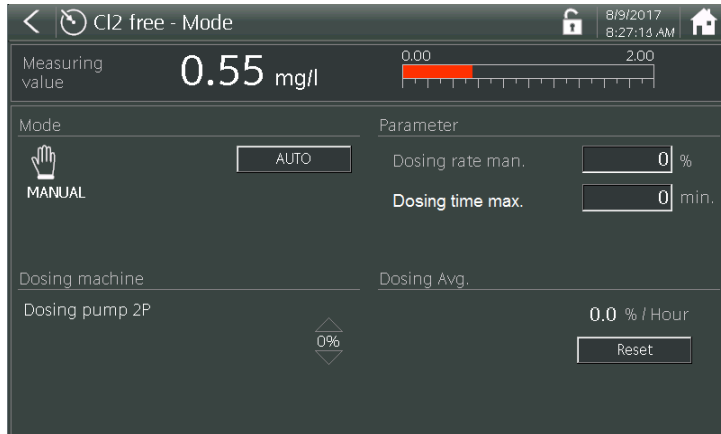

- 3 The selection option is shown or the keypad appears.
- 4 Press the “MANUAL” or “AUTO” button and the button changes from “MANUAL” to “AUTO” or from “AUTO” to “MANUAL”.
- 5 After the button has been pressed, a prompt appears “Do you want to switch to MANUAL or AUTO mode?”.
 - Confirm with “Yes” to change the operation mode.
 - Select “No” to cancel the process.
- 6 In “Manual mode,” it is possible to set a manual dosing rate for the controller outputs (not with dosing contact). The following settings are possible:

Dosing rate man.	0...100 %/open/closed
------------------	-----------------------

Furthermore, a runtime limitation can be set for manual dosing (not with positioner). Dosing is switched off after expiry of this time. If the running time is set to 00:00, it is inactive and manual dosing is in continuous mode.

Dosing time max.	0...1440 min.
------------------	---------------

- 7 When switching to Automatic, the feed delay is started. Select the “Start now!” button to stop the delay and start dosing immediately.
- 8 When the controller is activated, there is also the option to change the setpoint and reset the dosing average shown.

NOTICE

For each controller output, e.g. Cl₂, pH the operation mode must be set separately!

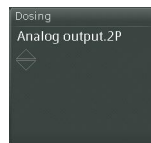

Menu field Dosing

- 1 Press the menu field „Dosing“.
- 2 The screen changes to the menu “CI2 - Dosing”. This setting menu gives the option to adapt the dosing output to the on-site conditions.

In this example, the menu of “CI2 free - Dosing” is displayed.

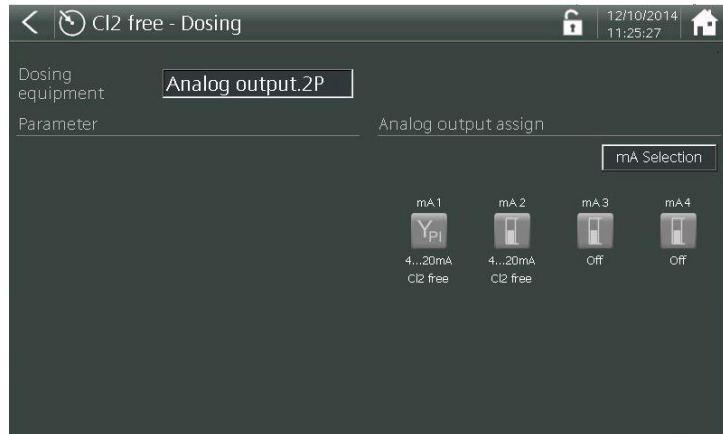

- 3 Select the desired input fields or symbols. The selection option is shown or the keypad appears.
- 4 Configure the settings.

Choose from the following options:

Cl₂ free dosing

Cl ₂ dosing	
Dosing output	<ul style="list-style-type: none"> • Electr.Pos. w. Ym (chlorine gas feed) • Dosing pump 2P • Analog output 2P • Dosing contact for Cl₂-Dosing with hysteresis and min. switch on time (e.g. for OSEC-A) • Electr.Pos. wo. Ym • Solenoid pump 2P

Parameter	
<ul style="list-style-type: none"> • Ty • Tp • Ym calibration • Ym calibration 0. 100 % • max. pulse/min 	<ul style="list-style-type: none"> • 10 to 180 s • 10 to 180 s • Auto (gas feed only) • Manual calibration (gas feed only) • 100/120/140/160/180
Min On	0 min to 10 h
Min Off	0 min to 10 h

pH Dosing

Dosing output	<ul style="list-style-type: none"> • Electr.Pos. wo. Ym (gas feed only) • Dosing pump 2P • Dosing pump 3P • Solenoid pump 2P • Solenoid pump 3P • Analog output 2P • Analog output 3P • Dosing contact
---------------	--

Parameter	
<ul style="list-style-type: none"> • Control direction • Tp • Xsh • Type • max. pulse/min 	<ul style="list-style-type: none"> • Acid / Alkali • 10 to 180 s • 1.0 to 5.0 % • 10 to 180 s • 100/120/140/160/180

Cl-N Dosing

Cl-N Dosing	
Dosing output	<ul style="list-style-type: none"> • Dosing output • Dosing pump 2P • Solenoid pump 2P • Analog output 2P

Parameter	
Min On	0 min to 10 h
Min Off	0 min to 10 h
Tp	10 to 180 s
max. pulse/min	100/120/140/160/180

Conductivity Dosing

Conductivity Dosing	
Dosing output	<ul style="list-style-type: none"> • Dosing pump 2P • Solenoid pump 2P • Analog output 2P • Dosing output

Parameter	
Tp	10 to 180 s
max. pulse/min	100/120/140/160/180
Min On	0 min to 10 h
Min Off	0 min to 10 h

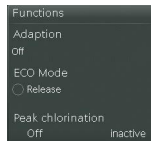

Menu field Functions

- 1 Press the menu field „Functions“.
- 2 The screen changes to the menu “Cl2 free - Functions”.

From this screen, you can switch to Adaption Peak (super) chlorination or ECO mode.

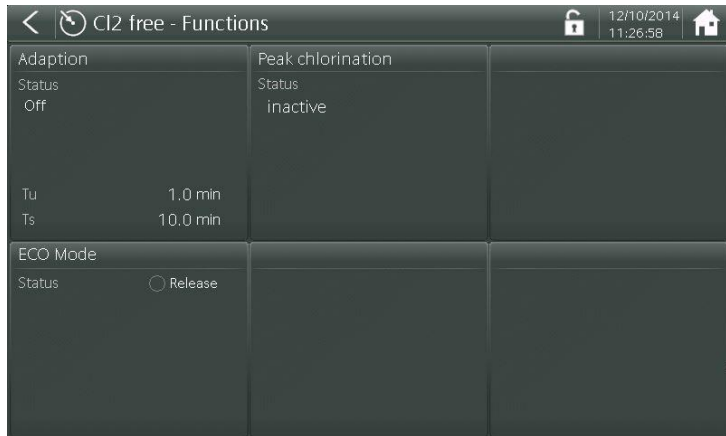

- 3 Select the corresponding settings.

The following settings can be realized:

Adaption

- 1 Press the menu field „Adaption“.
- 2 The screen changes to the menu “Cl2 free - Adaption”

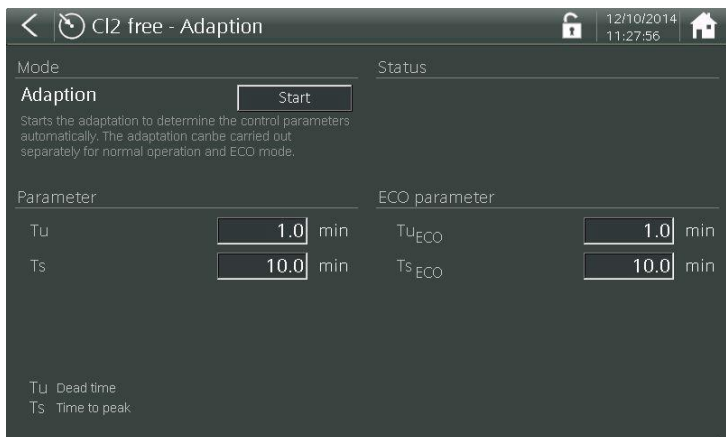

- 3 Press the “Start” button and the automatic adaption process starts, see Chapter 3.4.10 “Adaption (only applies to free Cl2)”.
- 4 Under “Parameter”, the last defined loop times Tu and Ts are displayed. Values for Tu and Ts can also be entered directly.

Peak (super) chlorination

- 1 Press the menu field „Peak chlorination“.
- 2 The screen changes to the menu „Peak chlorination“.

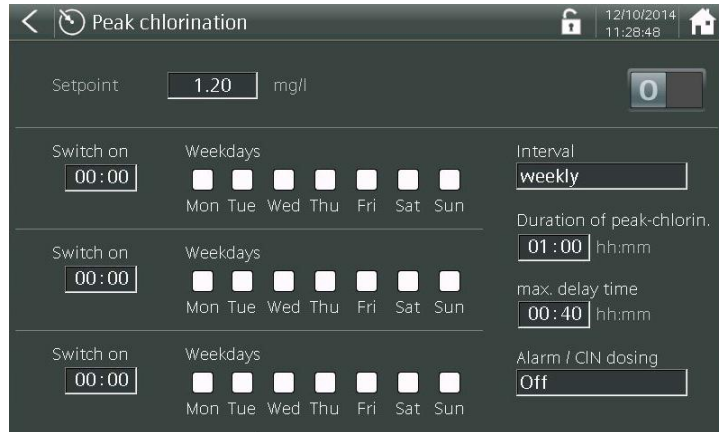

The following settings can be realized:

- To activate the peak chlorination function, set the Peak chlorination switch to “1”.
- To deactivate the peak chlorination function, set the switch to “0”.
- Three timers are available for which the switch-on time and weekday can be freely selected. All or specific week days can be selected. The interval selected can be weekly, every two weeks, three weeks or four weeks.
- Max. delay describes the maximum time allowed after peak chlorination has started until the peak chlorination setpoint is reached.
- The selection field “Alarm/CIN dosing” is used to disable alarms and the total chlorine controller during the peak chlorination. This should help limit the number of malfunctions.
- From the “Setpoint” input field, you can define the desired peak (super) chlorination value to be reached.

NOTICE

Allowing the pump to continue dosing upon reaching the maximum allowable time will void NSF certification.

- ECO mode*
- 1 Press the menu field "ECO mode".
 - 2 The screen changes to the menu „ECO mode”.

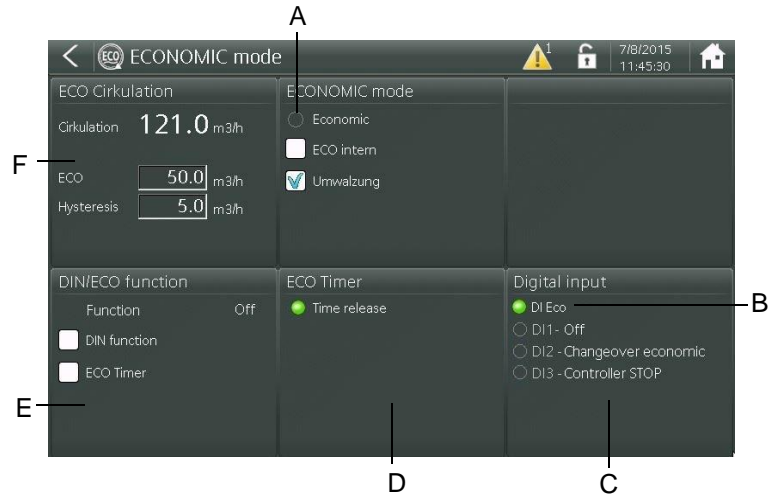

- A Lights up with ECONOMIC mode
- B Lights up with active DI contact
- C Digital inputs
- D ECO Timer
- E DIN/ECO function
- F ECO circulation settings

The following settings are available:

ECO circulation

If "Circulation" is selected in the „ECO mode” settings menu, the "ECO circulation" settings menu opens. Additional settings can be specified in this settings menu. The circulation signal is configured in the analog input settings menu and displayed accordingly. The ECO value and the hysteresis at which the Blu-Sentinel™ Pro electronics module switches to „ECO mode” are set in the „ECO circulation” settings menu.

ECO Timer	Selecting ECO Timer allows switching to ECO mode via the internal timer (ECO Timer).
Circulation	Selecting circulation allows for the automatic changeover in ECO mode if the value drops below the "ECO" limit value set in ECO circulation.

If both functions are selected, both criteria are considered for the ECO switchover.

DIN/ECO function

Function	Indicates whether the DIN function is active (green).
DIN/ECO contact	Indicates whether the DIN/ECO function is active (green).
DIN function	Selecting the DIN function activates monitoring of the DIN limit values and switches the DIN relay on if all values are within the DIN limits. If a selection is activated at the same time in the ECO Mode menu field (e.g. ECO Timer), the DIN function is also considered when switching to ECO mode.
ECO contact timer	Selecting the ECO contact timer switches the DIN relay regardless of the set time releases of the internal timer. If DIN function and ECO Contact Timer are activated, both functions are considered when switching the DIN relay.

If you select the "DIN Function," then DIN functionality is enabled, see "DIN contact" on page 100. Proceed as follows: Press the "DIN/ECO function" settings menu to open the "DIN contact" settings menu. The DIN parameters are entered in this settings menu.

Digital inputs

Digital inputs	Displays the current switching function of the digital inputs. Open contact = active (red)
----------------	--

The Blu-Sentinel™ Pro can be switched to ECO mode with different functions. One or several functions can be selected at the same time. All conditions must be met at all times for the electronics module to switch to ECO mode. When using a digital input for the ECO switchover, this input always has priority regardless of the other switching condition.

ECO Timer

Time release	Indicates whether Timer Release is active (green).
--------------	--

If "ECO Timer" is selected in the settings menu for "ECO Mode," ECO mode is triggered with an internal, programmable timer (see diagram below). Proceed as follows: Press the "ECO Timer" settings menu to open the "Time release" settings menu. In this settings menu, you can program up to three different on-duty and off-duty cycles and the corresponding days of the week.

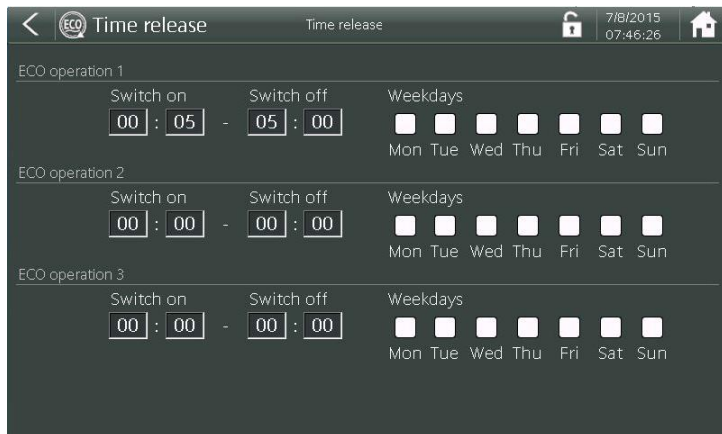

If you select both functions "ECO Timer" and "Circulation," both conditions must be met for the Blu-Sentinel™ Pro electronics module to switch to "ECO Mode." If the "DIN function" is selected in the "DIN/ECO function" settings menu, all DIN conditions must be met additionally for switching to ECO mode.

DIN/ECO functions

DIN function

Selecting the "DIN function" enables the DIN functionality (see "DIN contact" on page 100). Press the "DIN/ECO function" settings menu to open the "DIN contact" settings menu. The adjustable DIN parameters are entered in this settings menu.

ECO Timer

If "ECO Timer" is selected, the DIN relay is reconfigured to an ECO relay. Thus, the ECO timer function is output to the ECO relay which can be used for further external evaluations.

If both features are enabled, both conditions must be met as well for switching the DIN/ECO relay.

6.2.3 Inputs / outputs

- 1 Call up the basic screen.
- 2 Press the menu field "Inputs / outputs"
- 3 The screen changes to the menu "Inputs / outputs".

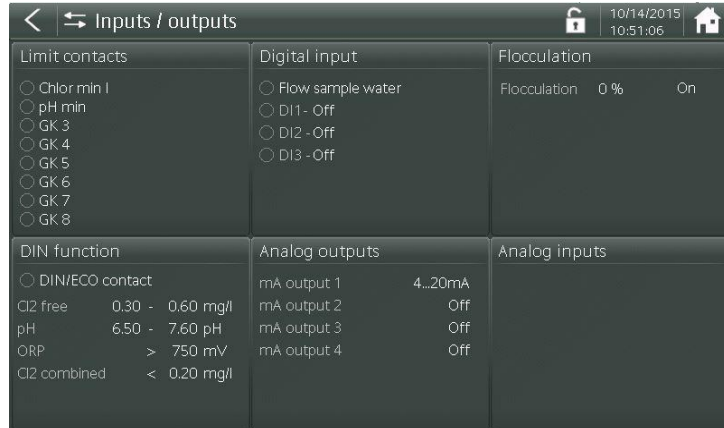

The following settings can be adjusted:

Limit contacts

- 1 Press the menu field „Limit contacts“.
- 2 The screen changes to the menu „Limit contacts“.

Up to a maximum of 8 limit contacts can now be configured. To do so, press the relevant contact.



- 3 Select the desired button (e.g. Contact 1) and realize the settings.

Each limit contact can be configured to one or more causes, e.g. common alarms. Where changes are made, confirm by selecting the OK button.

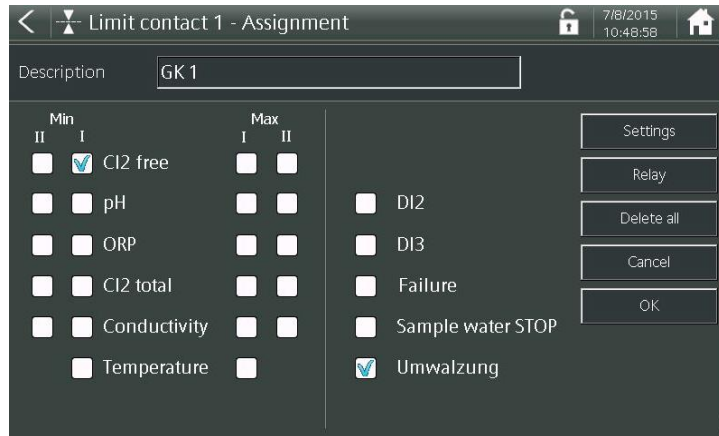

- 4 Press the „Settings” button.
- 5 The screen changes to the selected „limit contact” (in this example, Limit contact 1). Acknowledgment concept see Chapter 3.4.5 “Limit contacts”.

This screen is used to define the type or switching properties of the limit contact.

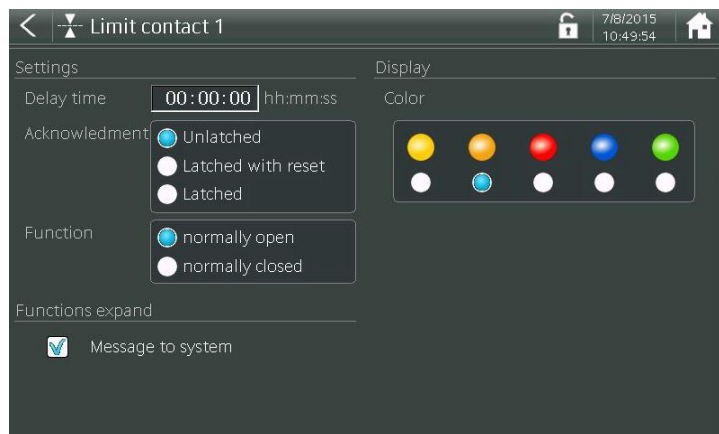

- 6 Press the “Relay” button, then you can assign relays to the limit contacts.

Use the above screen to select the switching properties, delay time and color signalling for the limit contact.

When the option “Message to message system” is activated, a message is generated in the message system parallel to the limit contact. Where the limit contact can be acknowledged, the color of the system bar and LED glow stick changes to red, or to yellow if not acknowledged.

- DIN contact*
- 1 Press the menu field “DIN function”.
 - 2 The screen changes to the menu “DIN contact”.



- 3 Select the buttons and change the entries.

The following entries or changes can be made:

DIN function	activates or deactivates the DIN contact
ECO-Contact Timer	activates or deactivates the ECO-Contact Timer
“Change” DIN limit values	Allows you to adapt the Min. and Max. limits of the measurements Cl ₂ , pH, ORP and Cl-N that are relevant to the DIN contact

- Flocculation*
- 1 Press the menu field „Flocculation”.
 - 2 The screen changes to the menu „Flocculation”.

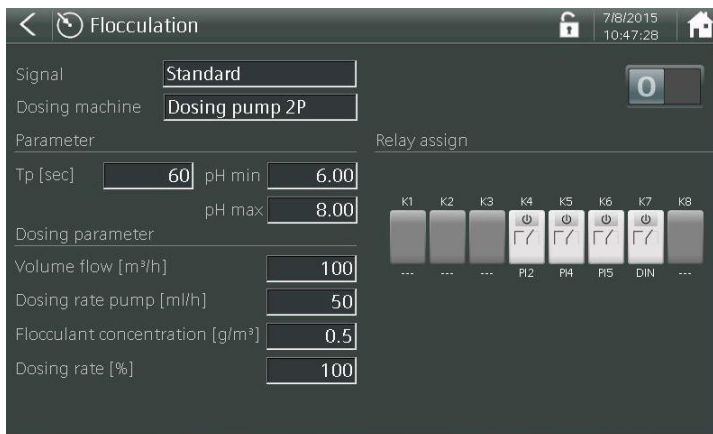

- 3 The flocculant dosing can be disabled or enabled by selecting the switch symbol.
- 4 Select the desired button and configure the settings.

The following entries or changes can be made:

Flocculation	0/1 switches flocculation off or on
Signal	Standard Default with ECO circulation mA input 2
Actuator	Dosing pump 2P Solenoid pump 2P Analog output 2P

Parameter

Tp	10 to 180 s
pH min	Within pH measurement range
pH max	Within pH measurement range

Dosing parameter

Volume flow	[m³/h]
Dosing rate pump	ml/h
Flocculant concentration	g/m³

Dosing output

Dosing rate [%]	0 to 100 %
Dosing rate ECO	0 to 100 %

- Digital inputs*
- 1 Press the menu field „Digital input”.
 - 2 The screen changes to the menu „Digital input”.

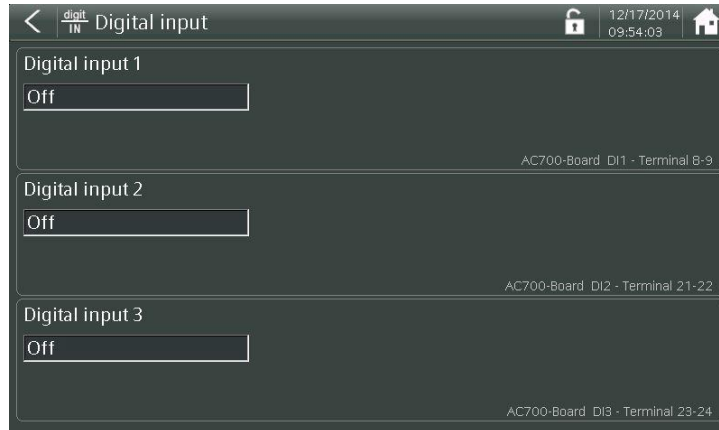

- 3 A function can be freely assigned for each digital input.
- 4 Press the desired selection field and select the function.
- 5 Depending on the function, additional option fields may appear.

The following functions are available:

Off	No function
Controller STOP	Stop the selected controllers when input active
Controller constant	The selected controllers keep the dosing constant when input current.
mA output constant	The selected mA outputs keep the signal constant when input current
Controller 100 %	The selected controllers have a 100 % dosing rate when input is active.
Controller 2x Yout	The selected controllers have a double dosing rate.
Economic Switching	Changes to ECO mode when input active.
Limit contacts	Limit contact configuration

Analog outputs

The mA outputs of the Blu-Sentinel™ Pro electronics module are galvanically isolated and can be configured to 0 – 5 mA, 0 – 10 mA, 0 – 20 mA oder 4 – 20 mA. Each measured value, dosing output Yout or temperature can be assigned to the mA outputs.

- 1 Press the menu field „Analog outputs“.
- 2 The screen changes to the menu „Analog outputs“.

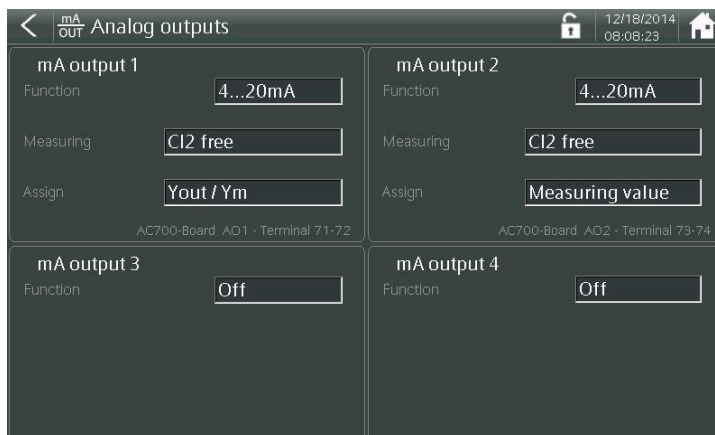

- 3 mA outputs that are not used for dosing, can be freely configured.
- 4 Select the output signals via the function (e.g. 4 – 20 mA).
- 5 Select measuring channel (e.g. CL₂ free).
- 6 Select the signal of the measurement channel (e.g. measuring value).

Analog inputs

The mA inputs of the Blu-Sentinel™ Pro electronics module share a ground and are potentially isolated from the rest of the electronics.

Adjustable functions:

Function	Off, 0 - 20 mA, 4-20 mA
Start	Freely definable
End	Freely definable
Format	Measurement display 0000 / 000.0 / 00.00
Unit	max. 5 digits (any combination)
Factor	0.1 - 4.0
Designation	max. 15 digits (any combination)
Controller STOP	Activation, adjustable switching threshold

Example:

Measurement range flow meter 0-500 m³/h

Maximum possible circulation volume 250 m³/h

=> Start: 0 m³/h
 End: 250 m³/h
 Format: 0000
 Unit: m³/h
 Factor: 2.0

Since the measuring range of the flow meter is not equal to the actual, maximum circulation volume, the factor in the example must be set to 2.0.

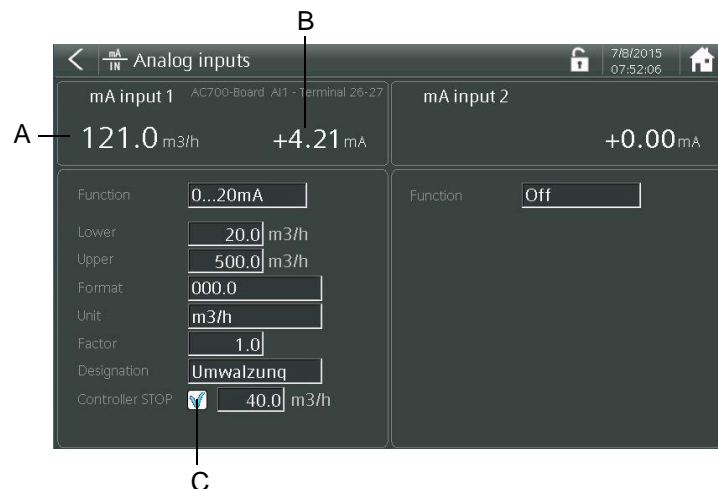

A Value A

B Value B

C Activation of the controller STOP function

The mA input 1 can be used to calculate the dosing line for flocculation and for switching to ECO mode. If the "Controller STOP" function is activated and the circulation capacity drops below the set value, all enabled controllers are switched to controller STOP mode.

The mA input 2 can be used only for the dosing capacity calculation of the flocculation pump.

The display (A) is calculated as follows:

$$A = \left(B(0 - 100\%) * \frac{end - start}{100\%} + start \right) * factor$$

6.2.4 System

In this menu, you can configure the system settings.

- 1 Call up the basic screen.
- 2 Press the menu field „System“.
- 3 The screen changes to the menu „System“.



In this screen, you can call up different menu fields:

- Set time/date (A)
- Operation mode (B)
- User (C)
- Settings (D)
- Expand screen ... (E)
- Acknowledge messages (F)

- 4 Select the corresponding menu fields.

Selecting the menu fields

The following menu fields can be selected:

Menu field Time/Date

11:42:48
Wednesday, December 10, 2014

- 1 Press the menu field „Time / Date”.
- 2 The screen changes to the menu „Date / Time”.



- 3 Press the input field for „Date / Time”.
- 4 The system keypad used to enter the date or time appears.
- 5 Enter the date or time.

Menu field Operation mode

Mode
Control system On

- 1 Press the menu field „Operation mode”.
- 2 The screen changes to the menu „Operation mode”.

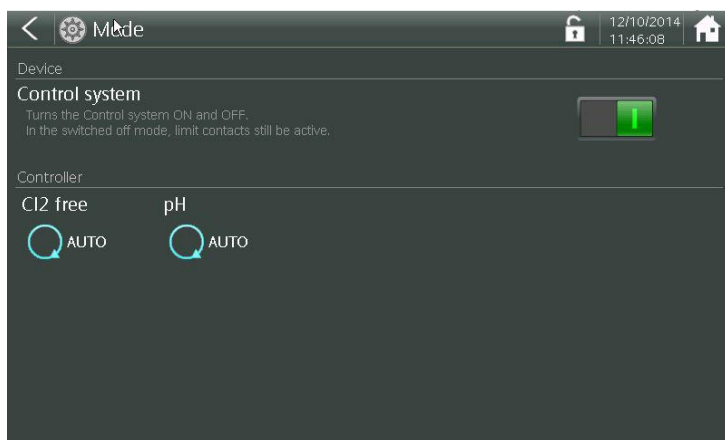

- 3 The control system can be switched on or off. To do so, press the button and select (I/O).



Menu field User

In the „User” menu field, the individual users and passwords are defined. For the Blu-Sentinel™ Pro electronics module, the following levels are available:

- User level
- Level 1 - Calibration
- Level 2 - Service
- Level 3 - Reset passwords

Proceed as follows to change the levels:

- 1 Press the „User” menu field.
- 2 The screen changes to the menu „User administration”. Three user levels are available.

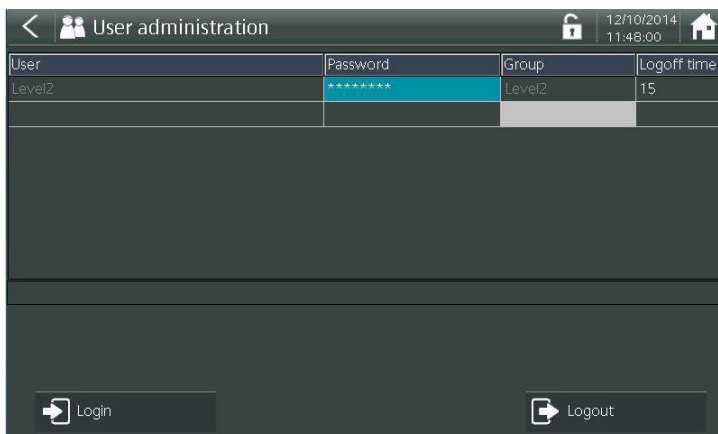

User level	<ul style="list-style-type: none"> • No password • Read access only • Operation mode can be changed
Level 1	<ul style="list-style-type: none"> • Password protection • Calibration possible • Includes all user level rights • Acknowledge messages
Level 2	<ul style="list-style-type: none"> • Password protection • Service level • Write access • Includes all Level 1 rights
Level 3	<ul style="list-style-type: none"> • Reset passwords

In as-delivered status, the automatic logout time is set to 0 minutes, i.e. the unit is not logged out automatically. An automatic logout time of 0 to 60 minutes can be set via the customer-specific password entry in Level 1 or 2. The automatic logout time means that the unit is automatically logged out if there is no operator input at the unit. The user remains logged in continuously if the automatic logout time is set to 0 minutes.

NOTICE

The system is supplied with the default password "0000". Password protection is only activated if it is not „0000“. The system is thereby always logged in to Level 2 and logging off is not possible.

- To activate the Level 2 password protection, a Level 2 password must be defined in the "Password" input field.
- To change the password, double-click on the blue input field under Password and follow the onscreen instructions.
- Password protection is only activated if it is not "0000".
- The Level 1 password is only activated if a Level 2 password has been defined that is not "0000".
- Both the Level 1 password and Level 2 password can only be changed by logging in to the relevant Login Level 1 or 2.

Level 1 calibration password

The calibration password allows access for calibration purposes and to display all menus. The password consists of multi-digit customer-specific number combinations with a minimum of 3 and a maximum of 24 digits.

To change the passwords, proceed as follows:

- 1 Open the blue input field under Password by double-clicking on it.
- 2 Enter the new password.
- 3 Enter the password again and confirm.

NOTICE

If the customer-specific user names and passwords have been lost, these can be reset to the default factory setting. In this case, contact the manufacturer.

NOTICE

For security reasons, the user names and passwords of all user levels must be replaced with customer-specific settings!

Level 2 service password

The system password allows full access to all set up options and display of all menus.

Service password:

Factory setting	User name	Level 2
	Password	0000

Calibration password:

Factory setting	User name	Level 1
	Password	0001

Reset passwords:

Factory setting	User name	Level 3
	Password	3001



Menu field Settings

From the „Settings” menu field, you can call up different buttons:

- 1 Press the menu field.
- 2 The screen changes to the menu „Settings”.

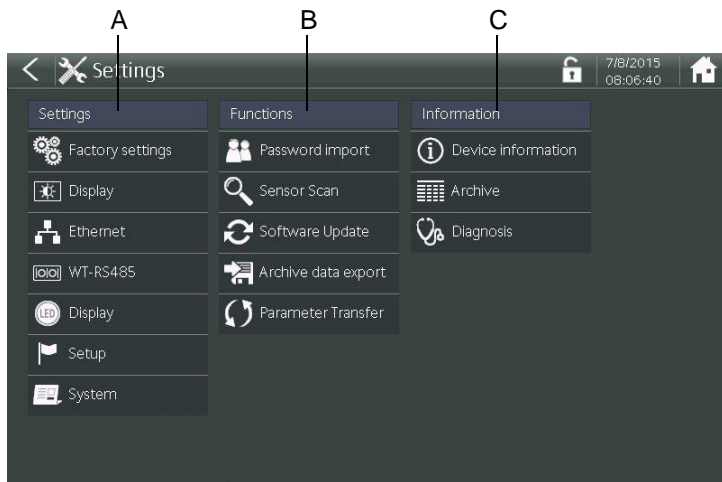

This screen allows you to switch to subordinate menus:

- Settings (A)
- Functions (B)
- Information (C)

Menu Settings

The following settings can be configured from the „Settings” menu:

Factory setting

Under Factory setting, the Blu-Sentinel™ Pro electronics module can be reset to the default factory supply condition.

- 1 Press the „Factory” button.
- 2 The prompt “Do you want to restore the factory settings?” appears. Select “Yes” to reset all settings.
- 3 As a precaution, another prompt appears to confirm the deletion.

Display

- 1 Press the „Display” button.
- 2 The screen changes to the menu „Display”.

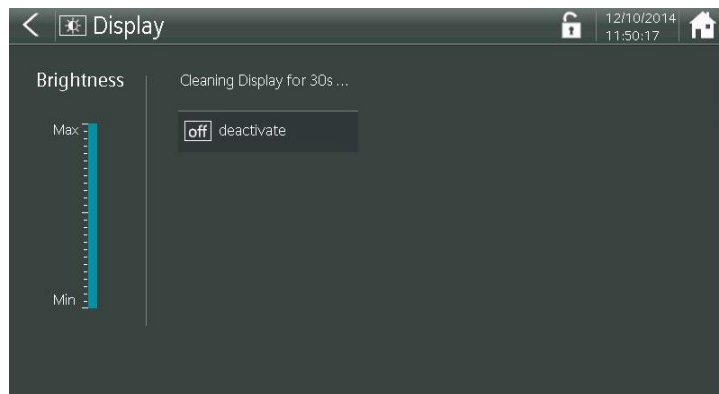

- 3 Use the brightness bar graph to set the backlit lighter or darker. To do so, press and slide the blue bar.
- 4 To clean up the display during operation, press the “off/deactivate” button and the whole operating area is disabled.

NOTICE

No further operation is possible.

Ethernet

- 1 Press the „Ethernet” button.
- 2 The screen changes to the menu „Ethernet status”.

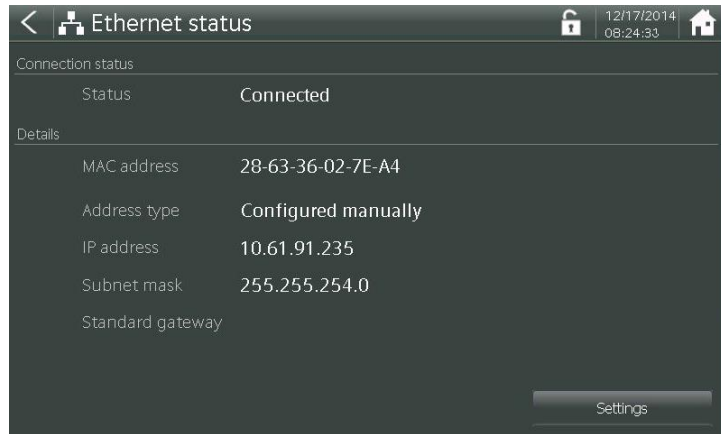

This screen shows the connection status, MAC address of the unit and the IP address settings.

- 3 Press the „Settings” button and the screen changes to the view where you can change the Ethernet settings (see Chapter 4.5 “Ethernet interface”).
- The system can be integrated in a network via two different IP configurations. In order to be able to configure the necessary settings, you may have to contact the network administrator.
 - When using DHCP, the setting “Obtain an IP address automatically” must be set.
 - To integrate the system in the network with a specific, fixed IP address, the setting “Use the following IP Address” must be defined. In the input field “IP address”, the assigned IP address (obtain from network administrator) must be entered. The Subnet mask and if necessary the Standard gateways must also be entered when manually assigning the IP address.
 - If the Ethernet interface is used for data communication via Modbus TCP, the parameter Modbus Port = 502 must also be set. The factory setting is Modbus Port = Off.
 - Changes to the IP configuration must be confirmed with the “Apply” button.

NOTICE

Factory setting

Address type:	Manually configured
IP address:	192.168.200.12
Subnet mask:	255.255.255.0

Parameter Transfer

To export the files, proceed as follows:

- 1 Plug the USB stick into the USB socket.
- 2 Use the input field (A) to enter a customer-specific file name.
- 3 Press the “Export” button.
- 4 The following is displayed when file transfer was successful:
"The data was successfully exported"

To import the files, proceed as follows:

- 1 Plug the USB stick into the USB socket.
- 2 Use the selection menu (B) to select the corresponding parameter file to be imported.
- 3 Press the “Import” button.
- 4 The following is displayed when file transfer was successful:
"xxx" parameters successfully imported
"xxx" parameters were replaced

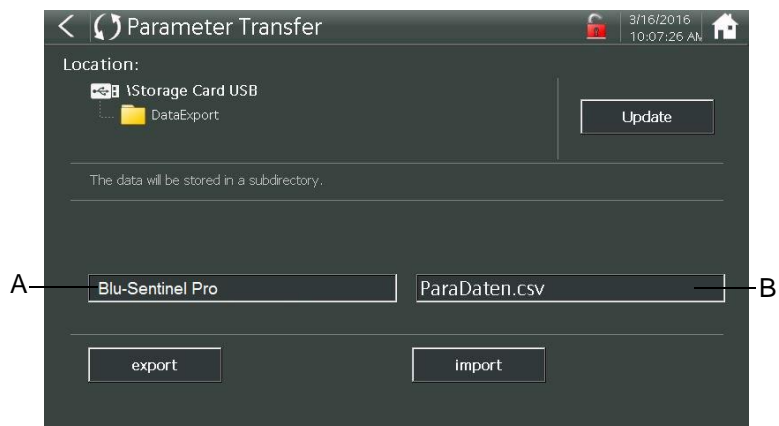

A *Input field "customer-specific name"*

B *Selection menu for the corresponding parameter file*

WT-RS485

- 1 Press the “WT-RS485” button.
- 2 The screen changes to the menu “RS485 port”.

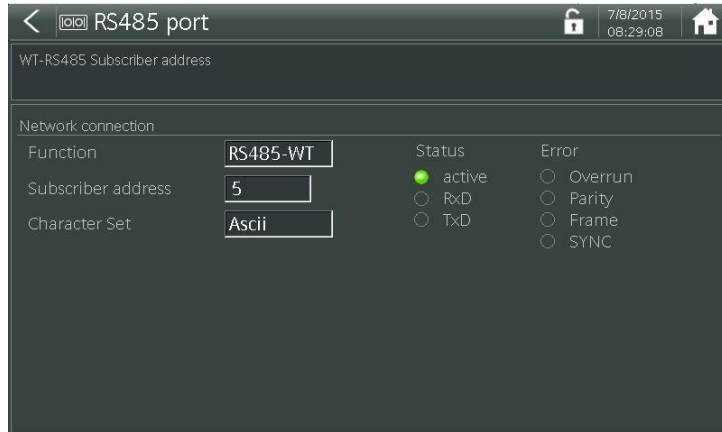

- 3 The RS485 interface function can be selected via the input field “Function.” To do this, tap the input field. Selection options are displayed. If Fieldbus is selected and a Fieldbus gateway is connected to the RS485 interface, various menus are shown, depending on the gateway.

The RS485 Interface supports bus communication with the Process Monitoring System or other higher-level systems that support the RS485-WT protocol.

The following communication protocols are possible:

- RS485-WT communication protocol for connection to OPC server, Process Monitoring system or higher-level control system.
- Fieldbus for connection of the Wallace & Tiernan Fieldbus converter.
- PCS485 for connection to older visualization systems that only support the RS485 protocol with 3-address operation (e.g. PCS devices). In this case, one bus address each must be set for chlorine, pH and redox.

- 4 If “RS485-WT” is selected, the RS485 bus address can be entered via the input field “Subscriber address.” Avoid double address assignment! To do so, tap and select the input field.
- 5 Various states and error LEDs are depicted in the right half of the screen.

Status:

Active - receives data

RxD - bus communication active

TxD - responds to a request

The error LEDs should not light up during trouble-free operation of the bus.

- LED display*
- 1 Press the “LED Display” button.
 - 2 The screen changes to the settings menu „LED output”,



- 3 Select the desired settings.

The following settings are possible:

LED alarm	Illuminates the cell body in various colors to indicate operation, warning, and malfunction states.
Dim	Dims the illumination of the cell body when the backlight of the display is dimmed.
Calibrate LED glow stick	Use this menu to adjust the illumination colors of the RGB LED of the LED glow stick to compensate for changes in color after aging. It is possible to adjust the red, green, and blue components.

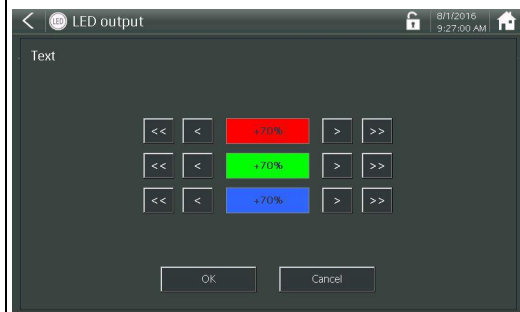

- Setup**
- 1 Press the “Setup” button.
 - 2 The screen changes to the menu „Setup”.

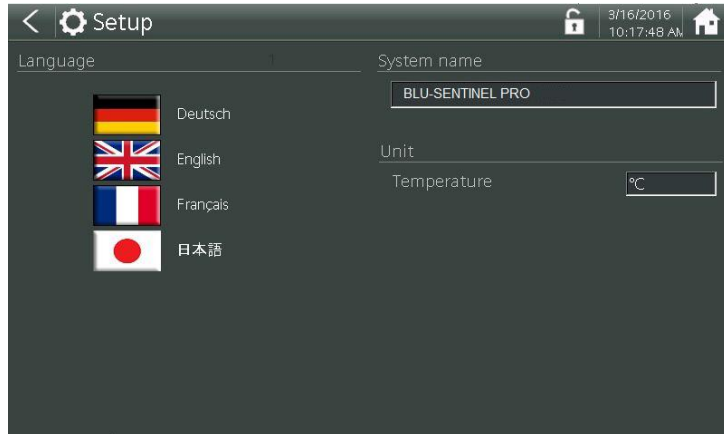

- 3 Press the “German” or “English” or “French” or „Japanese” symbol and select the desired language.
- 4 Select the „System name” input field and define a customer-specific name, e.g. children’s pool, swimmer’s pool. This appears in the system bar of the main screen.
- 5 Tap the input field “Temperature” and select the desired temperature measuring range (measuring range 0...50°C/ 32...122°F).

- System**
- 1 Press the „System” button.
 - 2 The screen changes to the menu ”System”.



- Controller outputs are integrated for the sensor channels Cl₂ free, pH, Cl₂ total and Conductivity.
- The controllers for Cl₂ free (Channel 1) and pH (Channel 2) are activated at the factory.
- ORP (Channel 3) has no controller output.
- Cl₂ total (Channel 4) and Conductivity (Channel 5) have controller outputs that are however deactivated at the factory and must be activated if required.

- 3 Under Control, set the relevant button to "1" (green) to enable it. The controllers can be switched on or off as needed. If controllers are deactivated, the switching outputs can be used as an alarm contact.
- 4 The corresponding values can be entered under Dosing. To do so, press and select the input field.

The following settings can be realized:

Maximum dosing time	
Description	The maximum dosing time determines the length of time that all control outputs can work at 100 % dosing rate in both manual mode and automatic mode. The respective controller output is switched off after this time. When the setting is "00:00:00", this function is switched off.
Setting range	00:00 to 10:00 h (hh:mm)

NOTICE

Disabling the overfeed timer by setting the maximum dosing time to 00:00 will void the NSF certification.

Feed delay	
Description	The feed delay delays the dosing start when the device is switched on and when the operating mode has been changed. The passing of the selected time can be interrupted with the "Start now!" button.
Setting range	00:00 to 60:00 (mm:ss)

Sample water delay	
Description	The sample water delay determines the time after which dosing is deactivated, e.g. in the event of sample water stop. Whilst the delay is running, the symbol  is displayed.
Setting range	00:00 to 10:00 (mm:ss)

Hold function	
Description	The hold function is used to either buffer all measuring values or keep them constant during calibration. This prevents the transmission of invalid control signals during the calibration process by the sensor and also the transmission of erratic values from measuring values via mA-signal and communication interfaces.

Menu Functions

In the „Functions” menu, you can call up different buttons:

Software update

A USB stick can be used to program new software versions on the Blu-Sentinel™ Pro electronics module. The new software files can be downloaded free of charge from our Homepage.

NOTICE

We recommend you save the settings on a USB flash drive before the update (Parameter Transfer menu), because they are deleted during the update. Re-import the data after the update.

Proceed as follows:

- 1 Copy the file onto a USB stick (no subfolder).
- 2 Switch the device off.
- 3 Plug the USB stick into the USB interface on the bottom of the device (unscrew the protective cap first).
- 4 Switch the device on and wait until the system displays the measured values.
- 5 Switch to the “Settings” menu.
- 6 Press the “Software update” button.
- 7 The screen changes to the “Software update” menu.
- 8 Follow the progress on the display. Programming is self-explanatory and is completed via the actual Start button.
- 9 Restart the system after the update.
- 10 All settings must be entered again.

Export of archive data

- 1 Plug the USB stick into the USB socket.
- 2 Press the “Export archive data” button.
- 3 The screen changes to the “Export - archive data” screen.

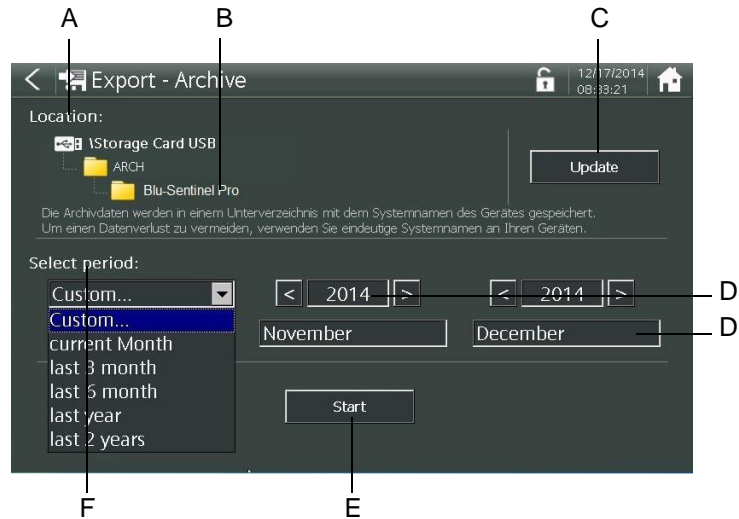

- A Location
 B System name of device
 C Update button
 D Expanded input fields
 E Start button
 F Period

- 4 Press and select the relevant buttons.

- Location:
 When a USB stick is plugged into the USB socket, the directory tree and archive location are shown. If no USB stick is plugged in or it has not been recognized, the message “USB flash drive is not available” appears.
- System name of device
- The “Update” button is needed to search for the USB stick.
- Expanded input fields
- Period:
 Different predefined time periods are available as the period for the archive data.
 When calling up Data export, the period “current month” is always selected.
 If “Custom...” is selected, additional input fields appear that can be used to determine the actual period.
- “Start” button:
 Press the “Start” button to export the data over the selected period.
 A progress bar appears which shows the current status.

The archive files are stored in CSV format on the internal SD card. A file is generated for each month. The data rate or data interval is two minutes. The archive file contains all main measurements, temperature, control outputs, and the measured values of both mA inputs.

Structure of the data name:

<p>anlaog_2014-11.csv</p> <p>2014 = year 11 = month</p>

Menu Information

In the Information menu, you can call up different buttons:

Device information

- 1 Press the “Device information” button.
- 2 The screen changes to “Device information”. This screen displays the connected hardware with the software versions and the presence of an SD memory card.

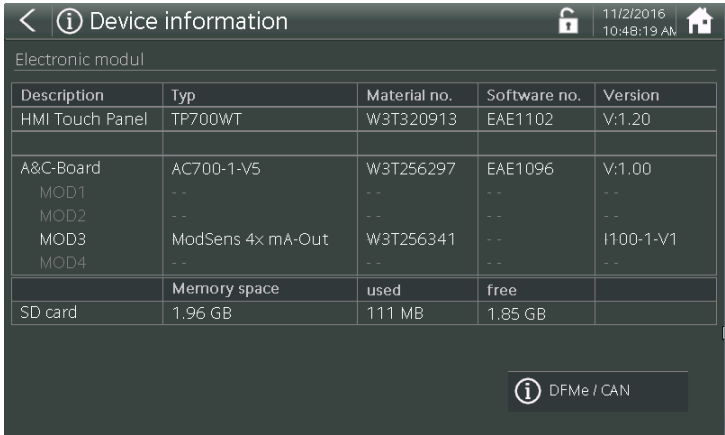

Diagnostics

The Diagnosis screen for the different measurements or its modules provide information about the operating conditions, serial numbers, options, part numbers, etc.

The Diagnosis screen or modules for Cl₂, pH, ORP, Cl-N and conductance values differ in several ways.

- 1 Press the „Diagnosis” button.
- 2 The screen changes to “Diagnosis - Overview”.
- 3 Select the “Cl₂ free” button.
- 4 The screen changes to “Diagnosis - Module Cl₂ free”.

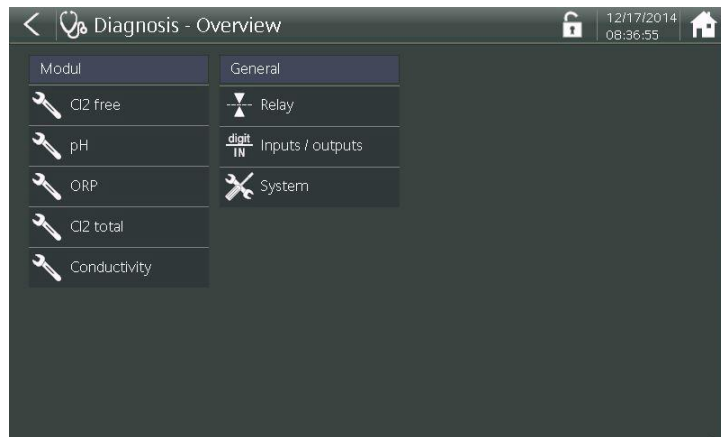



The following information is shown in the Diagnosis screen:

Identifier	Displays the module type: Cl ₂ free, pH, ORP or Conductivity
Device name	Shows the device's designation of the module: MultiSens DES-M, ModSens pH, ModSens ORP, SiDiSens LF
Serial number	Shows the serial number of the hardware
Hard version	Shows the company-specific hardware version of the module
At the bottom of the screen, the internal information is displayed that is not relevant to the customer.	

Menu field Message system

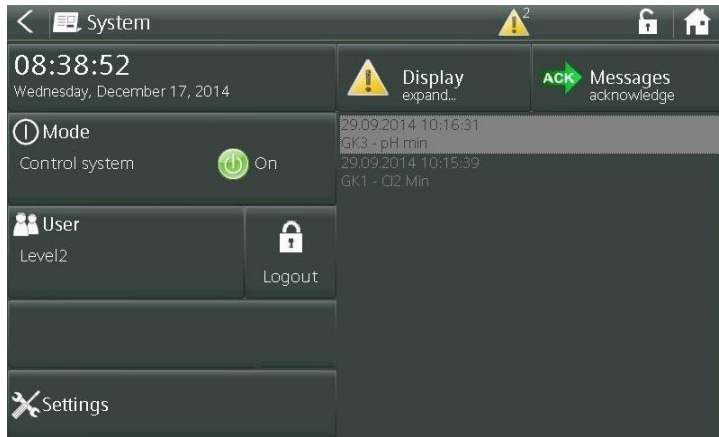
- 1 Press the message symbol .
- 2 The screen changes to the system menu. Here, all accumulated messages are displayed.



- 3 Messages that can be acknowledged can be confirmed by pressing the button “Acknowledge ACK messages”.
Depending on the type of message and the cause, the message is deleted immediately or it remains in the message window until the cause has been rectified. Each message is shown with a time-stamp to indicate when the message occurred.
- 4 Press the button “ Expand screen” and the messages appear clearly one after the other in a list.

6.2.5 LED glow stick color signaling

The color of the LED glow stick changes between blue, yellow and red depending on the operating state. The top line of the HMI display includes the same color change.

The change to the different colors has the following meaning:

Light blue	<ul style="list-style-type: none"> • All OK. • The device is working trouble-free. • No active errors or currently no message in the message system.
yellow	<ul style="list-style-type: none"> • Limit contact which is configured as “unlatched” and “Message to message system”, has been activated. <p>The message cannot be acknowledged. As soon as the cause is rectified and the limit contact is inactive, the yellow color signal changes back to light blue.</p>
Red	<ul style="list-style-type: none"> • Error message present. • A limit contact which is configured as “latched” and “Message to message system”, has been activated. <p>There are error messages that can be acknowledged or there is an error without acknowledgment.</p>

6.3 Calibration

Calibrations must be carried out with grab sample analysis - ideally photometric testing is performed.

The calibration is performed for new devices (first commissioning) and to recalibrate existing measuring instruments as part of regular pool operation.

NOTICE

A new controllers measurements must be calibrated before it is placed into control service. Subsequent calibration intervals may be dictated by local health codes.

6.3.1 Sensor calibration

CAUTION

Damage to sensor!

The electrode finger and membrane are extremely sensitive! Do not touch, soil or damage!
Note the safety data sheets for buffer solutions or calibration solutions.

CAUTION

Damage to device!

Before calibrating sensors that are placed in calibration solutions or buffer solutions, please make sure that the Blu-Sentinel™ Pro flow cell is unpressurized on the pressurized version.

Pressurized version calibration

Before or after calibration of the pressurized version of the Blu-Sentinel™ Pro flow cell, proceed as follows.

- 1 Close the ball valves on the sample water inlet and sample water outlet.
- 2 Release the pressure. To do so, open and close the drain briefly.
- 3 Run calibration.
- 4 Open the ball valves again on the sample water inlet and sample water outlet.

6.3.2 Temperature calibration

Proceed as follows:

- 1 Starting from the main screen, press the menu field with measuring value "Cl₂ free".
- 2 Select the menu field "Calibration". The window "Cl₂ free - Calibration" appears on the graphic display.
- 3 Select the parameter "Temperature".
- 4 Perform comparative temperature measurement.
- 5 Enter the value to be calibrated using the keypad.
- 6 Confirm the entry with the Enter key.

This concludes the temperature calibration.

6.3.3 Chlorine calibration

Chlorine calibration

With the chlorine calibration, each chlorine sensor (free chlorine or total chlorine) must be calibrated separately.

Free chlorine (Cl₂) calibration

With the calibration for free chlorine, a zero point calibration and a measuring value calibration (DPD1) must be realized.

NOTICE

NSF 50 Compliance Notice

To be within NSF 50 certification compliance, the following calibration instructions must be adhered to: After initial start-up of the Blu-Sentinel Pro controller, the free chlorine sensor must be calibrated when the chlorine grab sample measurement result is within plus or minus 0.20 mg/l of the desired free chlorine control setpoint to be within NSF/ANSI 50 compliance. The free chlorine sensor must be recalibrated thereafter if the grab sample measurement result used for the previous calibration differs by more than plus or minus 1.5 mg/l from the free chlorine measurement displayed on the controller.

NOTICE

To prevent the emission of non-permissible control signals during calibration, the "Hold function" in the system menu should be set to "On". mA-outputs and controller outputs then remain constant as long as a calibration menu is open.

Proceed as follows:

Zero point calibration

- 1 Starting from the main screen, press the menu field with measuring value "Cl₂ free".
- 2 Select menu field "Calibration". The window "Cl₂ free - Calibration" appears on the graphic display.
- 3 Close the ball valve on the sample water inlet.
- 4 Select the parameter "Zero".

NOTICE

Make sure that the chlorine sensor is firmly screwed in. Otherwise the measurement accuracy will be affected by inconsistent flow and inadequate sand cleaning.

When the sample water supply has been stopped, the display first drops rapidly, and after approximately one minute slowly approaches zero. During the first commissioning, it is essential to wait for 5 minutes, even if the display should show "0.00" or flash after a few seconds.

*Measuring value calibration
(DPD)*

- 5 Wait until the displayed chlorine value no longer changes.
- 6 Press „Apply" to set the display to "0.00".
- 7 Open the ball valve on the sample water inlet.
- 8 After zero point calibration, wait at least 2 minutes.
- 9 Open the sample taking unit (drain) by approximately one turn and extract a specimen of the sample water.
- 10 Determine the content of free chlorine in the sample using a photometer.
- 11 Select the parameter "DPD".
- 12 Use the input field to enter the determined value.
- 13 Confirm the entry with the Enter key.

Calibration for free chlorine is then concluded.

*Total chlorine calibration***NOTICE**

When calibrating the total chlorine or combined chlorine, only a one point calibration needs to be performed.

For the total chlorine calibration, proceed as follows:

- 1 Open the drain by approximately one turn and collect a sample water.
- 2 Determine the total chlorine content (DPD3) with a photometer or other grab sample test device.
- 3 Starting from the main screen, press the menu field with measuring value "Cl2 total".
- 4 Select the menu field "Calibration". The window "Cl2 total - Calibration" appears on the graphic display.
- 5 Select the parameter "DPD".
- 6 Use the input field to enter the determined value.
- 7 Confirm the entry with the Enter key.

This concludes the total chlorine calibration.

Combined chlorine calibration

When calibrating the combined chlorine, proceed as follows:

- 1 Determine the values for free chlorine (DPD1) and total chlorine (DPD3) as described under "Total chlorine" step 1 or 2.
- 2 Determine the value for combined chlorine:
Total chlorine DPD3 minus free chlorine DPD1 = combined chlorine
- 3 Starting from the main screen, press the menu field with measuring value "Cl2 combined".
- 4 Select the menu field "Calibration". The window "Cl2 combined - Calibration" appears on the graphic display.
- 5 Select the parameter "DPD".
- 6 Use the input field to enter the determined value as described under "Total chlorine".
- 7 Confirm the entry with the Enter key.

This concludes the combined chlorine calibration.

6.3.4 pH calibration

NOTICE

During pH calibration, the buffer solution and the sample water should have the same temperature. If the buffer solution and the sample water are at different temperatures, it is possible to enter the temperature value of the buffer solution for calibration during span alignment.

Proceed as follows:

pH7 alignment

- 1 Starting from the main screen, press the menu field with measuring value "pH".
- 2 Select the menu field "Calibration". The window "pH - Calibration" appears on the graphic display.
- 3 Select the "pH 7" parameter.
- 4 Fill the beaker with the buffer solution "pH 7.00" or use the bag with the buffer solution "pH 7.00".
- 5 Close the sample water inlet and outlet and open the sample taking unit (drain) briefly. Close the sample taking unit (drain) once more.
- 6 Pull or unscrew the pH sensor from the cover of the cell body of the flow cell.
- 7 Dip the pH sensor at least 2 cm (1 inch) deep into the buffer solution and move slightly until the indicated pH value remains constant.
- 8 Use the input field to enter the value of the buffer solution to be calibrated.
- 9 Confirm the entry with the Enter key.

Slope alignment

- 10 Remove the sensor from the buffer solution "pH 7.00".
- 11 Wash the sensor in distilled water to prevent carryover of the buffer solution.
- 12 Select the parameter "pH X".
- 13 If the sample water and the pH buffer solution are at different temperatures, the temperature value of the buffer solution should be entered under "Calibrate at" The value is deleted again when the menu "pH X" is closed.
- 14 Fill the breaker with the buffer solution "pH 4.65" or use the bag with the buffer solution "pH 4.65".

NOTICE

If buffer solutions other than those stated are used, the pH value of the buffer solution must be lower than pH 6 or higher than pH 8.

15 Dip the pH sensor at least 2 cm (1 inch) deep into the buffer solution and move gently until the indicated pH value remains constant.

16 Use the keypad to enter the value to be calibrated.

17 Confirm the entry with the Enter key.

18 Remove the pH sensor from the buffer solution.

19 Insert or screw the pH sensor into the cover of the cell body of the flow cell.

20 Open the sample water inlet and outlet once more.

The pH measurement is then calibrated.

Offset compensation

If external influences result in a constant difference between the displayed pH value and a pH value measured manually, this difference can be compensated.

Proceed as follows:

1 Starting from the main screen, press the menu field with measuring value "pH".

2 Select the menu field "Calibration". The window "pH - Calibration" appears on the graphic display.

3 Select the "Offset" parameter.

4 Using the keypad, enter the comparative value.

5 Confirm the entry with the Enter key.

The pH offset is then concluded.

NOTICE

The calibration offset is deleted each time a new pH-7 alignment or span alignment is performed.

The offset values between a new offset calibration and a previous offset calibration are additive (the controller automatically adds them). For this reason first enter an offset of „0" and then enter the actual set value from the grab sample analysis.

6.3.5 ORP calibration (mV)

NOTICE

ORP sensors have long running-in times. After calibration with a calibration solution, it can therefore take several hours until the measuring value has stabilized.

Proceed as follows:

- 1 Starting from the main screen, press the menu field with measuring value "ORP".
- 2 Select the menu field "Calibration". The window "ORP - Calibration" appears on the graphic display.
- 3 Select the "Cal. value" parameter.
- 4 Fill the breaker with the calibration solution "478 mV" or use the bag with the calibration solution "478 mV".
- 5 Close the sample water inlet and outlet and open the sample taking unit (drain) briefly. Close the sample taking unit (drain) once more.
- 6 Pull or unscrew the ORP sensor from the cover of the cell body of the flow cell.
- 7 Dip the ORP sensor at least 2 cm (1 inch) deep into the calibration solution and move slightly until the indicated value remains constant.
- 8 Use the keypad to enter the value to be calibrated.
- 9 Confirm the entry with the Enter key.
- 10 Remove the ORP sensor from the calibration solution.
- 11 Insert or screw the ORP sensor into the cover of the cell body of the flow cell.
- 12 Open the sample water inlet and outlet once more.

ORP calibration is then concluded.

6.3.6 Conductivity calibration

NOTICE

The conductivity sensor has an integrated temperature sensor and therefore an automatic temperature compensation feature.

Proceed as follows:

- 1 Starting from the main screen, press the menu field with measuring value „Conductivity“.
- 2 Select the menu field “Calibration”. The “Conductivity - Calibration” window appears on the graphic display.
- 3 Select the parameter “Cal. value”.
- 4 Fill the breaker with approx. 25 ml of the calibration solution “60.0mS/cm” or use the bag with calibration solution “60.0 mS/cm”.
- 5 Close the sample water inlet and outlet and open the sample taking unit (drain) briefly. Close the sample taking unit (drain) once more.
- 6 Pull or unscrew the conductivity sensor from the cover of the cell body of the flow cell.
- 7 Dip the conductivity sensor into the calibration solution to the bottom of the beaker.
- 8 Pull out the conductivity sensor and rinse off with distilled water.
- 9 Repeat the dipping and rinsing procedure several times.
- 10 Replace the calibration solution with a new one.
- 11 Repeat the measurement. Move the conductivity sensor slightly until the displayed value remains constant.
- 12 Use the keypad to enter the value to be calibrated.
- 13 Confirm the entry with the Enter key.
- 14 Insert or screw the conductivity sensor into the cover of the cell body of the flow cell.
- 15 Open the sample water inlet and outlet once more.

Conductivity calibration is then concluded.

6.4 Errors and remedies

6.4.1 Error messages

The following table shows and explains all possible error messages which can be displayed. If several errors occur at the same time, the corresponding messages appear alternately in succession. Once the error has been corrected, the error message is automatically deleted.

If it is not possible to remedy the fault or error yourself, please contact your affiliate.

The error messages of the Blu-Sentinel™ Pro electronics module are displayed as a plain text message in the menu field of the measurement in question. Error messages can occur that can be acknowledged or not acknowledged.



Errors that can be acknowledged

All of the following errors can be acknowledged. These are acknowledged via the system menu and the ACK button or “Acknowledge messages”.

Error message	Cause	Remedy
Maximum dosing time?	The maximum dosing time set for a control output has been exceeded.	Determine the cause, e.g. chemical tank empty. Check the dosing pump.
Adaption?	Adaption terminated with error.	Refer to Chapter 3.4.10 “Adaption (only applies to free Cl ₂)”.
Peak chlorination?	Rise time > max. delay or exceeding of the μA measurement range by the sensor during peak chlorination.	Increase max. delay time or select higher measurement range.

Errors that cannot be acknowledged

All of the following errors cannot be acknowledged and can only be rectified by eliminating the cause.

Error message	Cause	Remedy
Measured value display flashes	Measured value is outside the measurement range	Check measurement range and change, if necessary. Check dosing or controller settings
Positioner feedback flashes red	Line break/short circuit/feedback potentiometer: The positioner is defective.	Replace the positioner
Positioner feedback flashes white	Positioner in manual mode	Press in the adjustment knob on the positioner
	Sample water flow recently insufficient (delay running)	Check the sample water flow rate (approx. 33 l/h)
	Sample water flow rate insufficient for some time (delay elapsed).	Clean or replace the preliminary filter. Multi-sensor incorrectly connected or defective.
Zero ?	3-electrode measuring cell: Sensor has zero current $> +5 \mu\text{A}$ or $< -5 \mu\text{A}$	Upot potential voltage set incorrectly; change, if necessary. See page 80. Electrodes of 3-electrode measuring cell are dirty, if necessary clean / service. Sample water is not turned off or check valve leaks; turn off sample water, if necessary.

Error message	Cause	Remedy						
DPD ?	<p>Slope error</p> <p>The current difference required for span alignment over the entire measurement range was less than the minimum value.</p> <p>Range: Minimum current difference</p> <table border="0" data-bbox="499 660 815 757"> <tr> <td>10 µA</td> <td>0.04 µA/mg/l</td> </tr> <tr> <td>100 µA</td> <td>0.4 µA/mg/l</td> </tr> <tr> <td>1000 µA</td> <td>4.0 µA/mg/l</td> </tr> </table>	10 µA	0.04 µA/mg/l	100 µA	0.4 µA/mg/l	1000 µA	4.0 µA/mg/l	<p>Check Cl₂ sensor.</p> <p>Clean electrodes.</p> <p>Check the pH value of the water (< pH 8).</p>
	10 µA	0.04 µA/mg/l						
	100 µA	0.4 µA/mg/l						
1000 µA	4.0 µA/mg/l							
Organic chlorine compounds (e. g. high concentration of chlorine stabilizer chloroisocyanurate) in the water.	Do not add high concentration of chlorine stabilizers (<30 mg/l) to the water.							
Incorrect Upot for Cl ₂ sensor.	Set Upot: 250 mV, see page 80.							
Calibration pH7 ? Calibration pHX ? Calibration ? Offset calibration ?	3-electrode measuring cells: Slope error - the sensor current based on 1 mg/l has fallen below the required minimum.	Clean 3-electrode measuring cells, replace cleaning sand.						
	pH: In pH 7 calibration, the sensor signal is outside -100 to +100 mV or the sensor issues a signal outside 46 to 70 mV per pH increment, the calibration point distance is smaller than 1 pH increment.	Check the electrode. Check the buffer solutions, replace if necessary.						
	ORP: The ORP electrode (blue) correction offset is outside -50 to +50 mV.	Check the electrode. Check the calibration solution, replace if necessary.						
	Conductivity: Conductivity measurement spread is smaller than 0.8 or larger than 1.2.	Clean the sensor, check it and if necessary, replace it.						
Measuring cell ?								
Calibration of factory ?	Hardware or electronic fault	Contact Service.						
Setpoint ?	Due to modification of the measurement range, the controller setpoint is outside the measuring range.	Reset the controller setpoint or adjust the measurement range.						
Limit value ?								
Cl2++ ?	pH<6 or pH>8.75 pH measurement is not available.	Check the pH measurement, check DFMe electronics, check CAN bus setup.						

Error message	Cause	Remedy
Cl ₂ combined ?	Free Cl ₂ measurement is not available.	Check the DFMe electronics, check CAN bus setup.
Overfeed ?	The maximum dosing time set for a control output has been exceeded.	Determine the cause, e.g. chemical tank empty. Check the dosing pump.
Adaption ?	Adaption terminated with error.	See Chapter 3.4.10 "Adaption (only applies to free Cl ₂)".
CAN measuring value ?	No CAN bus subscriber.	Check CAN bus, set parameters for CAN subscribers.
Temperature ?	Interruption in the temperature sensor or cable of the multi-sensor.	Check multi-sensor and cable.
Sample water ?		
Positioner Ym ? (only when using Wallace & Tiernan chlorine gas feed equipment)	Ym range too narrow.	Check the gap between the calibration points.
	Positioner position incorrectly calibrated.	
	Positioner selected, but not connected.	Check setting: Positioner with Ym.
	Feedback signal incorrectly set.	Check DIP switch for feedback.
Positioner feedback incorrectly connected or defective.	Check (refer to 9. "Wiring Diagrams").	
Calibration Ym ? (only when using Wallace & Tiernan chlorine gas feed equipment)	Positioner calibration incorrect.	Check calibration of actuator feedback.
mA output 1 ? mA output 2 ? mA output 3 ? mA output 4 ?	Load error The mA output cannot drive its mA output current through the connected current loop (500 Ohm at 20 mA max.).	Check whether the mA signal is required at all (e.g. for plotter). If not, switch off the output signal in the "INPUTS/OUTPUTS" menu, "Analog output". Check mA signal cable for interruption
Flocculation ?	pH value outside the flocculation limit values.	Check flocculation limit values. Check pH measurement and control.

Error message	Cause	Remedy
Peak chlorination ?	Rise time > max. delay or exceeding of the μ A measurement range by the sensor measuring module during peak chlorination.	Increase max. delay time or select higher measurement range.
Hardware ?	Hardware or electronic fault	Contact Service.
EEProm storage ?	Hardware or electronic fault	Contact Service.
Cell ?	<p>3-electrode measuring cell: Chlorine sensor not screwed in. No sand cleaning. Sensor, sensor cable or sensor measuring module defective. Sensor measuring module μA measuring range exceeded.</p> <p>pH, F⁻ and ORP modules: Sensor, sensor cable or sensor measuring module defective.</p> <p>Conductivity modules: Sensor, sensor cable or sensor measuring module defective.</p>	<p>Screw in sensor correctly.</p> <p>Check sand cleaning.</p> <p>Check the sensor, sensor cable or sensor measuring module, replace if necessary.</p> <p>Select higher μA measurement range.</p> <p>Check the sensor, sensor cable and sensor measuring module, replace if necessary.</p> <p>Check the sensor, sensor cable or sensor measuring module, replace if necessary, clean sensor.</p>
Module ?	Sensor measuring module was removed Sensor measuring module defective.	Refit or replace the sensor measuring module
Measuring range?	Min. or max. limit value is outside the measuring range.	Check the min/max limit values and change, if necessary.
mA Input 1 ? mA Input 2 ?	mA input signal exceeded or not reached.	Check mA connection or signal.
CAN actuator?	No CAN actuator.	Check CAN bus, set parameters for CAN subscribers.
Ym display flashing	Positioner unlocked.	Engage positioner to Automatic.

6.4.2 Error

The following table shows and explains possible errors which can occur. If it is not possible to remedy the fault or error yourself, please contact your affiliate.

Errors	Cause	Remedy
No indication on device	No power supply.	External switch or fuse on.
	Device fuse defective.	Check the power supply and replace fuse (Electrician).
Device not showing a measurement	Sensor measuring module has been changed or added.	Start sensor scan.
Displayed/output value incorrect	Change on sensor or in the sample water.	Calibrate
Low control quality (controller swings, setpoint not reached)	Incorrect control parameters.	Check, adjust controller parameters; perform automatic adaption on single feedback closed-loop control.
	Dosing chemical tank empty.	Fill, replace.
	Incorrect actuator selected.	Check, correct actuator.
	Positioner or pump defective.	Check, replace positioner/pump.
Measured value display not available, although the appropriate measuring module is installed	Measuring module defective or fitted incorrectly.	Check, replace measuring module (Electrician).
Positioner/pump does not work	Positioner in manual mode.	Engage manual knob.
	Dosing device selected incorrectly.	Select correct dosing device.
	Positioner/pump incorrectly connected.	Connect the positioner/pump correctly. (Electrician).
	Relay defective.	Check (electrician).
	Incorrect application.	Check (see "Adaption" or 9. "Wiring Diagrams").
Positioner runs in wrong direction	Positioner incorrectly connected.	Correct connections (electrician).
Positioner closes	Positioner feedback interrupted.	Correct connections (electrician).
Digital inputs without function	Digital inputs not activated.	Activate digital inputs.

7. Maintenance

⚠ DANGER

Risk of injury or death!

External voltages may be connected even with the operating voltage switched off.



⚠ WARNING

Risk of electrical shock!

Disconnect all power sources before servicing.

Line voltage (120/240VAC) can be present inside the Blu-Sentinel™ Pro electronics module and caution should be used to prevent electrical shock, burns or electrocution. Be sure electric power is disconnected before opening the cover of any Blu-Sentinel™ Pro. Follow all local safety policies, procedures and electrical codes, to prevent injury from electrical hazards, before opening the cover of this controller. If you are not trained and comfortable performing work on electrical equipment, contact a licensed electrician to perform the work.

7.1 Maintenance intervals

NOTICE

Liability for defects can only be accepted if maintenance work is performed as specified. Adhere to the applicable standards and national and regional regulations.



⚠ WARNING

Daily comparative measurements are required!

Check the water quality on daily comparative measurements. Calibrate if necessary.

⚠ WARNING
Maintenance the device!

Inspect the device at least once daily for externally visible and faults! Remedy all fault and error messages.

Activity	Period/Interval
Blu-Sentinel™ Pro electronics module	Change batteries after 5 years

7.2 Changing the fuses on the A&C board

⚠ DANGER
Risk of injury or death!

External voltages may be connected even with the operating voltage switched off. Disconnect all power sources before opening the Blu-Sentinel™ Pro electronics module.

⚠ WARNING
Risk of injury!

Only authorized and qualified electricians are permitted to open the housing of the Blu-Sentinel™ Pro electronics module . The Blu-Sentinel™ Pro electronics module does not have a mains switch.

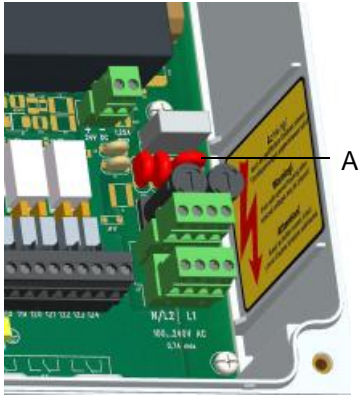

- 1 Disconnect the Blu-Sentinel™ Pro electronics module from the power supply.
- 2 Remove the housing cover of the Blu-Sentinel™ Pro electronics module.
To do this, unscrew the housing cover and remove carefully. Hook it into the holders on the basic housing.
- 3 Screw on the screw-in fuse holder F1/F2.
- 4 Change the defective fuse.
- 5 Screw the screw-in fuse holder back in.
- 6 Refit the housing cover of the Blu-Sentinel™ Pro electronics module. Tighten the housing screws to a maximum torque of 0.7 Nm (± 0.15 Nm).

Image 1 Section of Blu-Sentinel™ Pro electronics module - fuses

A Fuses

7.3 Replacing the battery

⚠ DANGER

Risk of injury or death!

External voltages may be connected even with the operating voltage switched off. Disconnect all power sources before opening the Blu-Sentinel™ Pro electronics module.



⚠ WARNING

Risk of injury!

Only authorized and qualified electricians are permitted to open the housing. The Blu-Sentinel™ Pro electronics module does not have a mains switch.

The battery is required for the real time clock in case of a power failure. If the time is not correct or if time controlled functions show faulty behavior, the battery must be changed. After five years at the latest.

Proceed as follows:

- 1 Disconnect the Blu-Sentinel™ Pro electronics module from the power supply.
- 2 Remove the housing cover of the Blu-Sentinel™ Pro electronics module. To do this, unscrew the housing cover and remove carefully. Hook it into the holders on the basic housing.
- 3 Unplug the cable with the DSub plug.
- 4 Pull the old battery and holder out of the HMI.
- 5 Remove the battery from the holder and dispose of in accordance with the regulations.



Attention!

Do not throw away or burn the battery. The batteries must be disposed of in accordance with environmental protection regulations.

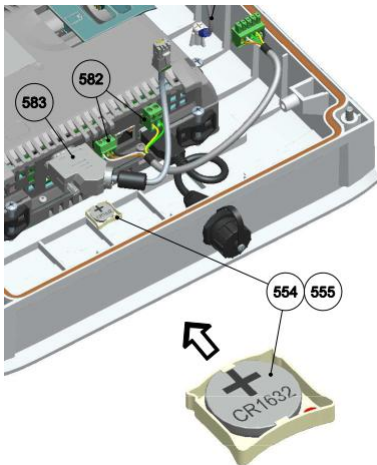

- 6 Insert the new battery, type CR1632.
- 7 Fit the battery holder and new battery into the HMI.
- 8 Plug the cable with the DSub plug in again and screw back on tightly.
- 9 Refit the housing cover of the Blu-Sentinel™ Pro electronics module. Tighten the housing screws to a maximum torque of 0.7 Nm (± 0.15 Nm).
- 10 Switch on mains voltage.
- 11 Set the date and time.

Image 2 Section of Blu-Sentinel™ Pro electronics module - battery

7.4 Cleaning

Do not use aggressive cleaning agents (e.g., alcohol, abrasive cleaners)! We recommend a damp cloth moistened with a commercially available neutral detergent.

8. Retrofit kits and spare parts

8.1 Retrofit kits

The Blu-Sentinel™ Pro electronics module (module type E01) gives the option to retrofit components that are not included when the product was purchased.

The following retrofit kits are available:

- 4-way relay board
- Fieldbus converter for wall-mounted devices
- Fieldbus converter for control cabinet installation devices

8.1.1 4-way relay board

See drawings Chapter “Explosion drawing Blu-Sentinel™ Pro electronics module” on page 145 and on page 146.

Item	Part No.	Designation
510	W3T320084	4-way relay board

8.1.2 Fieldbus converter

Part No.	Designation	Supply voltage	Fieldbus type	Connection
Fieldbus converter for wall-mounted (accessories)				
W3T162700	Fieldbus converter WA Profibus DP Terminals	100 to 240 V AC	Profibus DP	Screw terminals
Fieldbus converter for control cabinet (accessories)				
W3T162703	Fieldbus converter CA Profibus DP Terminals	24 VDC	Profibus DP	Screw terminals
W3T162704	Fieldbus converter CA Profibus DP D-Sub	24 V DC	Profibus DP	9-pole D-Sub plug

8.2 Installing retrofit kits

8.2.1 Installing the 4-way relay board

Proceed as follows:

- 1 Disconnect the Blu-Sentinel™ Pro electronics module from the power supply.
- 2 Remove the housing cover of the Blu-Sentinel™ Pro electronics module. To do this, unscrew the housing cover and remove carefully. Hook it into the holders (B) on the basic housing.
- 3 Install 4-way relay board at position A.

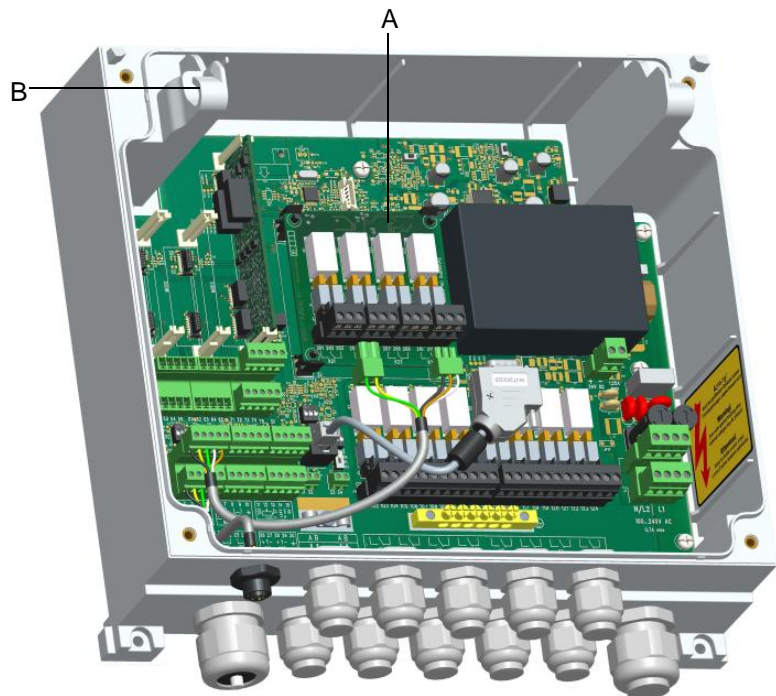

Image 1 Cross-section of Blu-Sentinel™ Pro electronics module

- 4 Wire in accordance with the wiring diagram (see Chapter 9. "Wiring Diagrams").

NOTICE

Please note that the shield of the analog signal line may only be grounded on one end.

- 5 Refit the housing cover of the Blu-Sentinel™ Pro electronics module. Tighten the housing screws to a maximum torque of 0.7 Nm (± 0.15 Nm).
- 6 Switch the Blu-Sentinel™ Pro electronics module back on again.
- 7 The Blu-Sentinel™ Pro electronics module automatically detects the installed modules and enables the corresponding settings menus.

8.2.2 Installing the Fieldbus converter

For instructions, refer to the separate instruction manual “Fieldbus converter”.

8.3 Spare parts

8.3.1 Blu-Sentinel™ Pro electronics module (module type E01)

NOTICE

For reasons of safety, only use original spare parts. Please contact our customer service if you need any spare parts.

See drawings on on page 145 and on page 146.

Item	Part No.	Designation
	W3T320002	Blu-Sentinel™ Pro electronics module (module type E01)
521	W3T247667	Basic housing for Blu-Sentinel™ Pro electronics module
522	W3T320030	A&C Board
523	W2T504397	Plastic self-tapping screw d4x10
524	W3T263330	CAN bus connection
526	W3T160551	M20x1.5 hex nut
527	W2T504179	M20x1.5 cable gland
528	W2T504212	M20 blind plug
529	W3T160552	M25x1.5 hex nut

Item	Part No.	Designation
530	W2T542498	M25x1.5 cable gland for assembly of cables with pre-assembled connectors
531	W2T503976	6x25mm bolts
532	W2T504180	M25x1.5 cable gland
533	W2T804252	M25 blind plug
551	W3T247669	Housing cover for Blu-Sentinel™ Pro electronics module
553	W3T326731	HMI TP700P (incl. plastic tensioner and battery)
553	W3T360781	HMI TP700P, reconditioned (Incl. plastic tensioner and battery)
554	W3T263405	Battery carriage
555	W2T555401	Lithium coin cell battery CR1632
556	W3T277475	Plastic tensioner for HMI
558	W3T263402	USB connection
559	W3T263403	Protective cap for USB connection
560	W3T319670	Strain relief cable
561	W2T504397	Plastic self-tapping screw d4x10
564	W3T260714	M5 cover screw
581	W2T806599	Industrial 2GB SD memory card
582	W3T263329	RJ45 connection cable A&C Board/HMI
583	W3T263328	RS485 connection cable A&C Board/HMI
584	W3T341054	Product strip Blu-Sentinel™ Pro
	W2T506813	Fine-wire fuse
	W3T345599	Touch pen for HMI operation
	W2T819286	Touch pen holder, self-adhesive

Explosion drawing Blu-Sentinel™ Pro electronics module

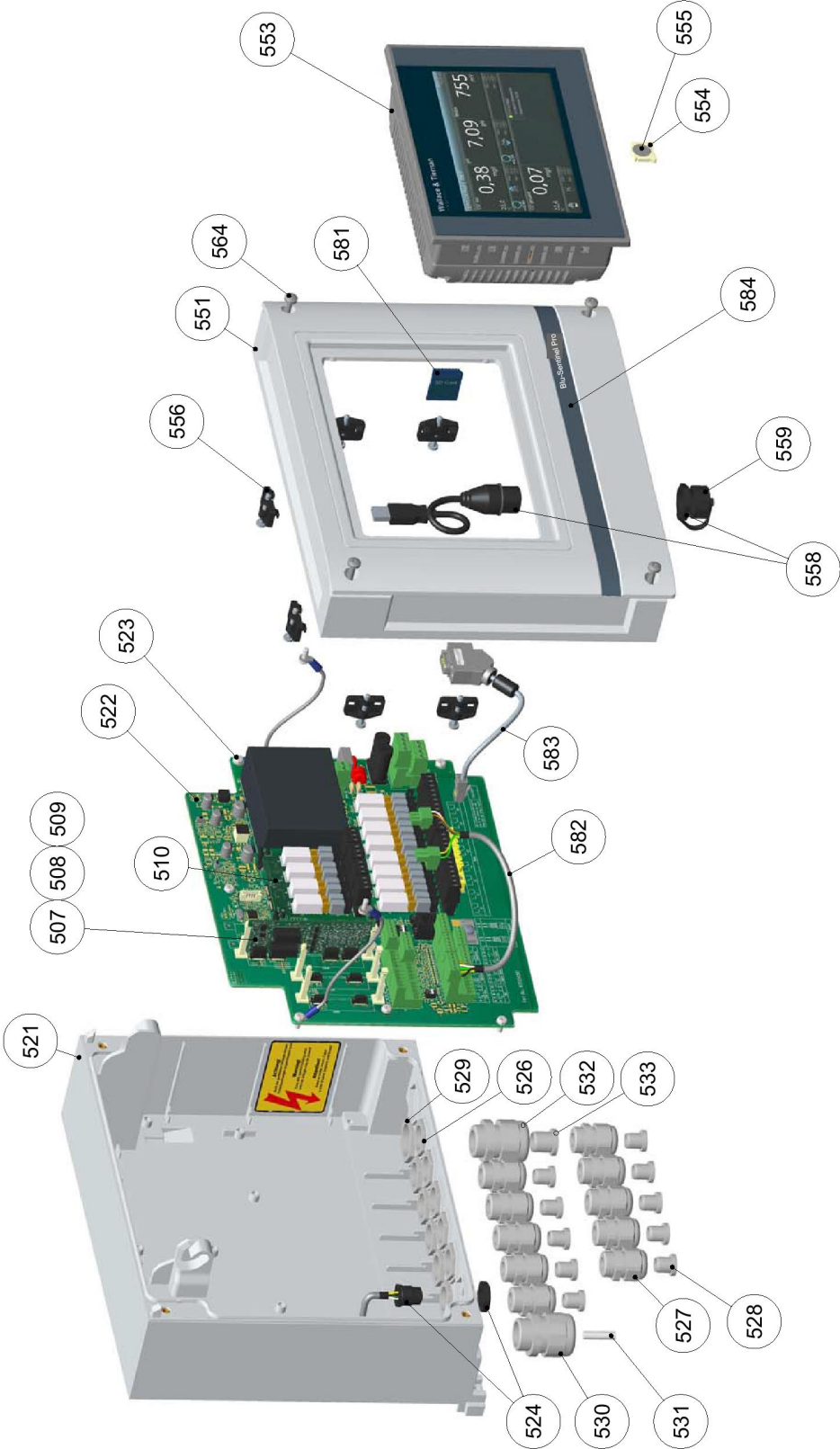

Explosion drawing Blu-Sentinel™ Pro electronics module

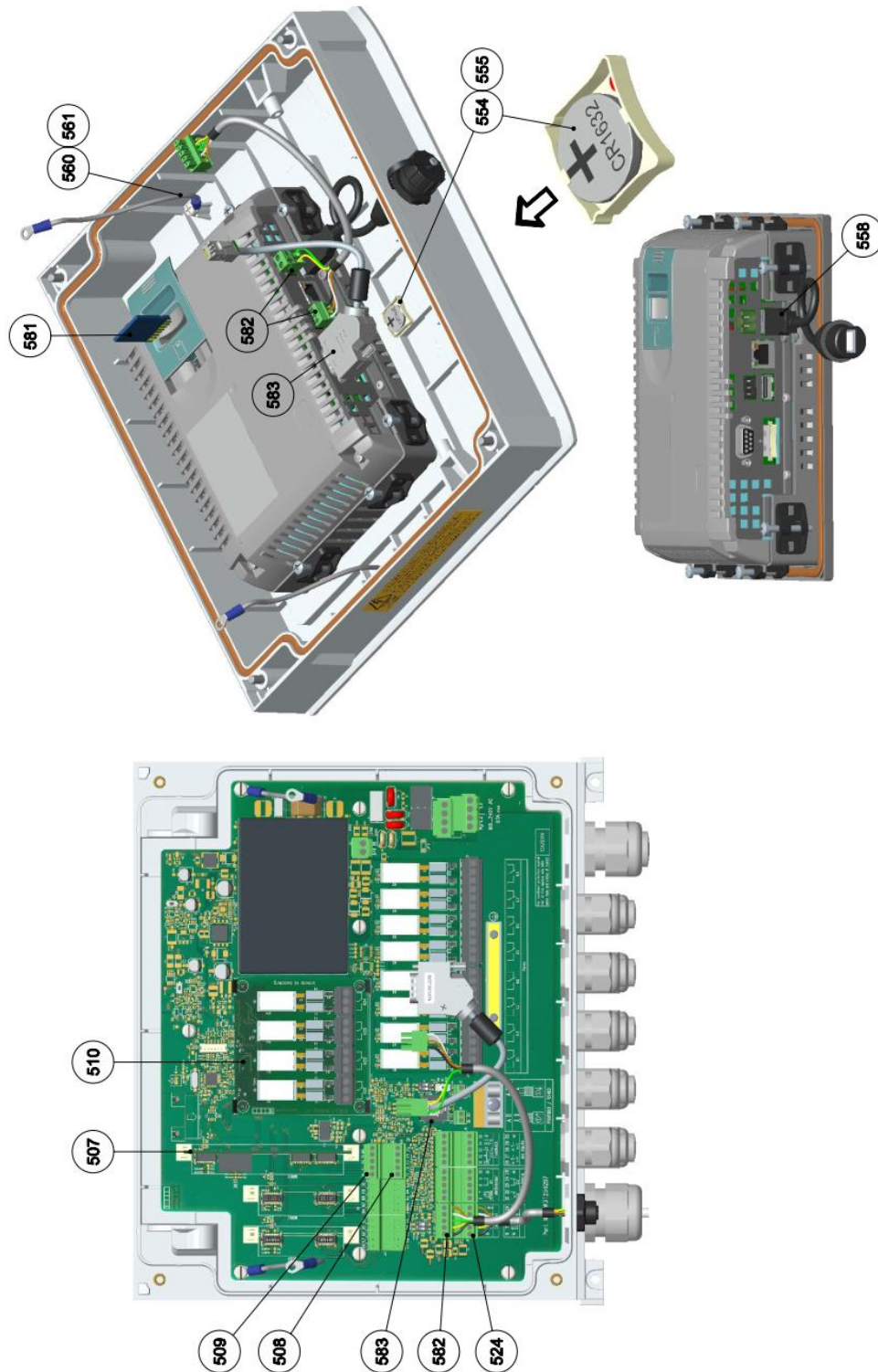

8.3.2 Accessory kit for the cable gland

The following accessory kit is also available for the cable gland:

Part No.	Designation
W3T314845	Accessory kit, comprising: multi-cable sealing insert, reducing sealing ring, bolts and fine-wire fuse (2x W2T506813)

8.3.3 RS485 bus interface

The following accessory is available for the RS485 bus interface:

Part No.	Designation
W2T505559	RS485 data cable

8.3.4 4-way mA output card

Item	Part No.	Designation
507	W3T320083	4-way mA output card

NOTICE

See drawings on page 145 and on page 146. Install the mA output card at position 507, 508 and 509 and make sure that the holders engage.

8.3.5 Instruction Manuals

Artikel-Nr.	Bezeichnung
W3T386191	Instruction Manual Blu-Sentinel™ Pro electronics module
W3T386192	Instruction Manual Blu-Sentinel™ Pro flow cell

9. Wiring Diagrams

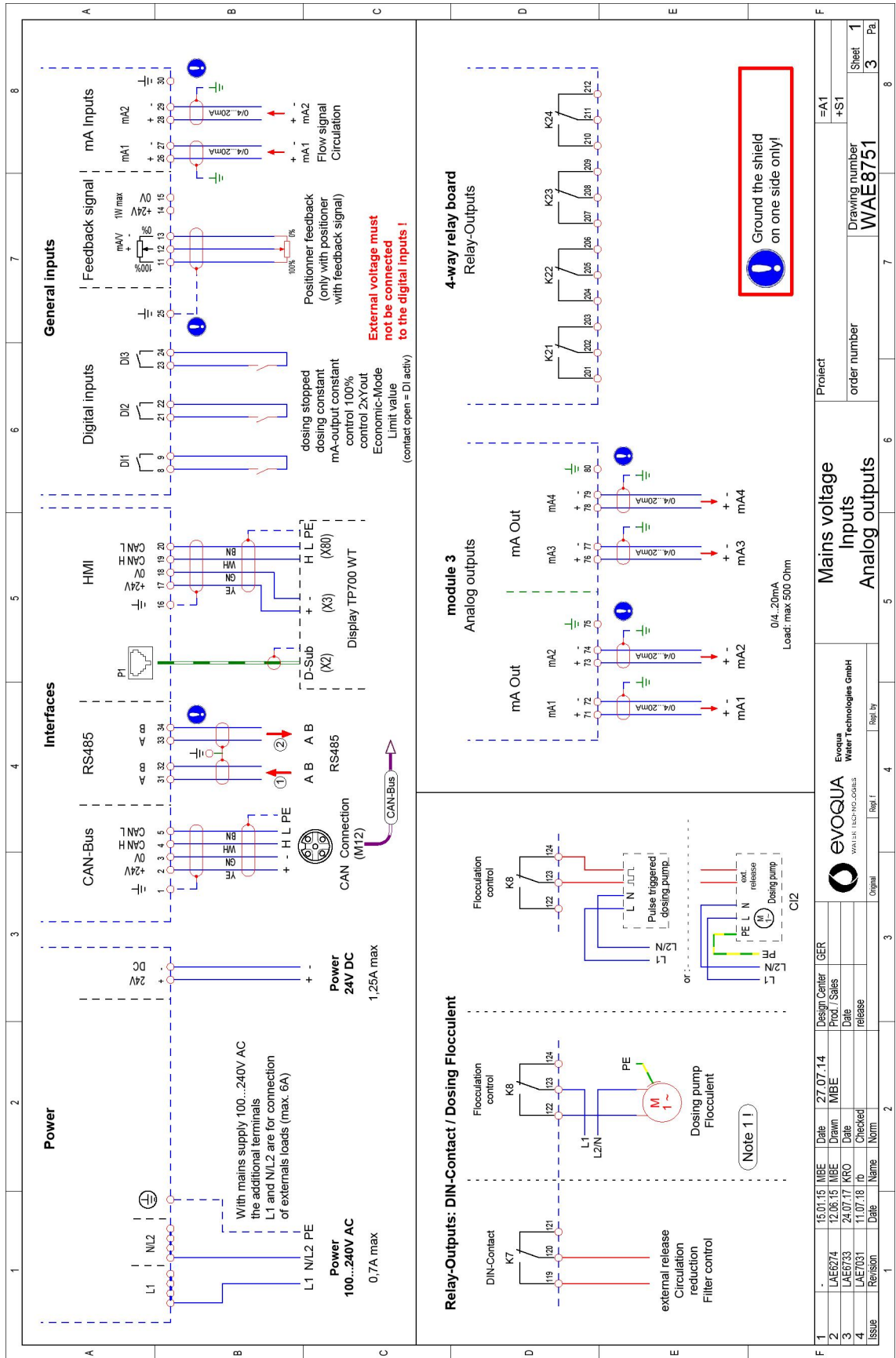

Project		=A1	
order number		+S1	
Drawing number		WAE8751	
Sheet		1	
Page		3	

EVOQUA		Evoqua Water Technologies GmbH	
WATERSHED TECHNOLOGIES		Reg. F.	
Original	Rev. 1	Rev. 1	Rev. 1

1	15.01.15	IMBE	Date	27.07.14	Design Center	GER
2	LAE6274	12.06.15	IMBE	Drawn	MBE	Prod / Sales
3	LAE6733	24.07.17	KRO	Date		release
4	LAE7031	11.07.18	rb	Checked		
Issue	Revision	Date	Name	Norm		

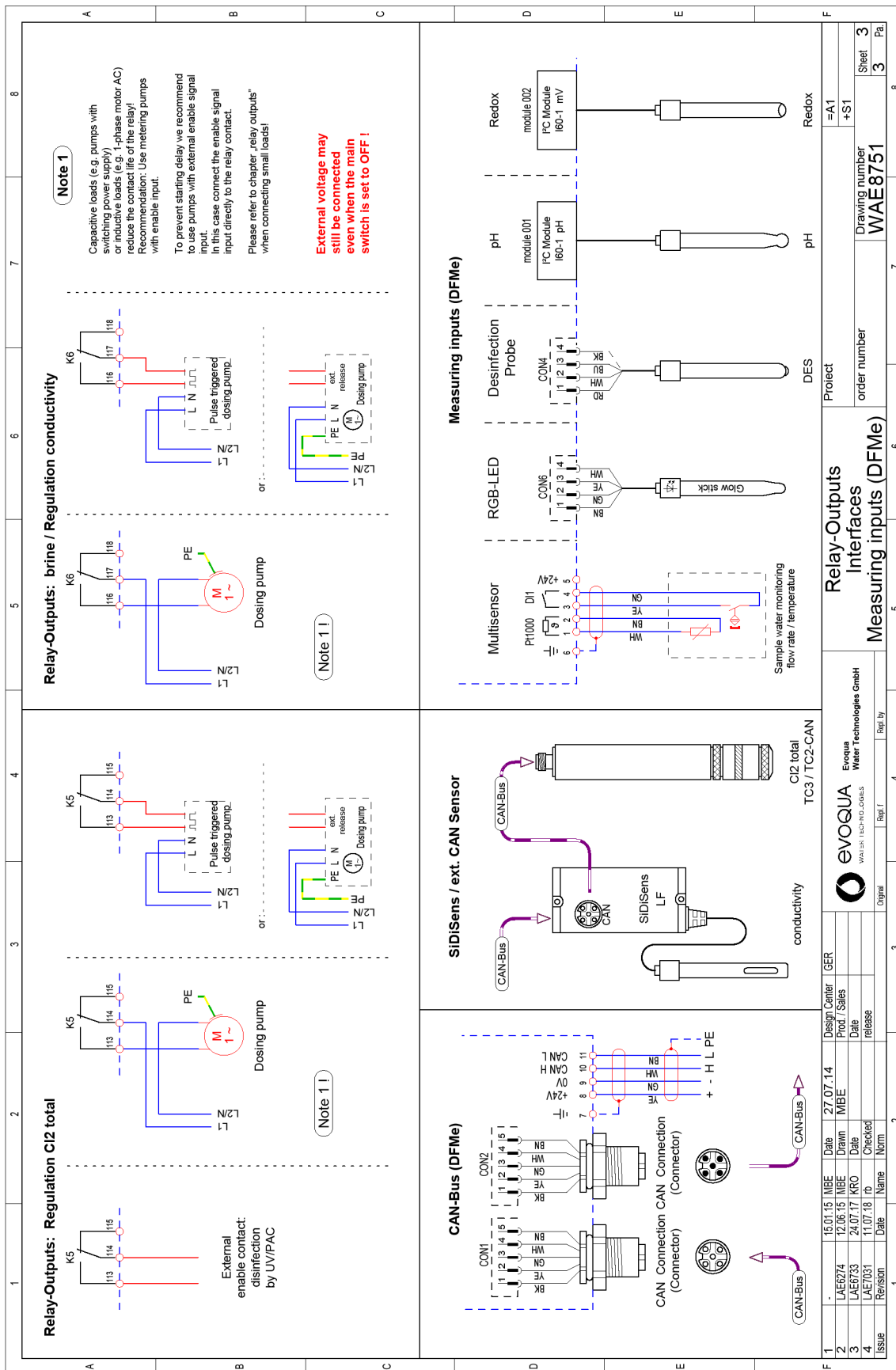

10. Declarations and certificates

10.1 Declaration of Conformity



EG-Konformitätserklärung EC Declaration of Conformity Déclaration CE de conformité

No. MAE1562

Ausgabe/issue/édition 04

Hersteller/Manufacturer/Constructeur:	Evoqua Water Technologies GmbH
Anschrift/Address/Adresse:	Auf der Weide 10, D-89312 Günzburg
Produktbezeichnung: Product description:	Elektronik-Modul 700 P (E01), Elektronik-Modul Blu-Sentinel Pro (E01)
Description du produit:	700 P electronics module (E01), Blu-Sentinel Pro electronics module (E01) Module électronique 700 P (E01), Module électronique Blu-Sentinel Pro (E01)

Das bezeichnete Produkt stimmt in der von uns in Verkehr gebrachten Ausführung mit den Vorschriften folgender europäischer Richtlinien überein:

The product described above in the form as delivered is in conformity with the provisions of the following European Directives:

Le produit désigné est conforme, dans la version que nous avons mise en circulation, avec les prescriptions des directives européennes suivantes :

2014/30/EU	<p>Richtlinie des Europäischen Parlaments und des Rates vom 26. Februar 2014 zur Harmonisierung der Rechtsvorschriften der Mitgliedstaaten über die elektromagnetische Verträglichkeit.</p> <p><i>Directive of the European Parliament and of the Council of 26 February 2014 on the approximation of the laws of the Member States relating to electromagnetic compatibility.</i></p> <p>Directive du Parlement européen et du Conseil du 26 février 2014 relative au rapprochement des législations des Etats membres concernant la compatibilité électromagnétique.</p>
2014/35/EU	<p>Richtlinie des Europäischen Parlaments und des Rates vom 26. Februar 2014 zur Harmonisierung der Rechtsvorschriften der Mitgliedstaaten betreffend elektrische Betriebsmittel zur Verwendung innerhalb bestimmter Spannungsgrenzen.</p> <p><i>Directive of the European Parliament and of the Council of 26 February 2014 on the harmonisation of the laws of Member States relating to electrical equipment designed for use within certain voltage limits.</i></p> <p>Directive du Parlement européen et du Conseil du 26 février 2014 concernant le rapprochement des législations des Etats membres relatives au matériel électrique destiné à être employé dans certaines limites de tension.</p> <p>CE-Kennzeichnung / CE marking / Marquage CE: 2017</p>



Die Konformität mit den Richtlinien wird nachgewiesen durch die Einhaltung der in der Nachweisdokumentation aufgelisteten Normen.
Evidence of conformity to the Directives is assured through the application of the standards listed in the relevant documentation.
 La conformité avec les directives est assurée par le respect des normes listés dans la documentation technique correspondante.

Benannte Person für technische Unterlagen:

Authorized person for the technical file:

Personne désignée pour la documentation technique:

Name / name / nom: Evoqua Water Technologies GmbH

Adresse / address / adresse: Auf der Weide 10, D-89312 Günzburg

Günzburg, den / the 2017-07-25

Evoqua Water Technologies GmbH

Klaus Andre
 Technischer Leiter / Director Engineering

Unterschrift
 signature / signature

Helmut Fischer
 Leiter QM / Quality Manager

Unterschrift
 signature / signature

Diese Erklärung bescheinigt die Übereinstimmung mit den genannten Richtlinien, ist jedoch keine Beschaffenheits- oder Haltbarkeitsgarantie nach §443 BGB. Die Sicherheitshinweise der mitgelieferten Produktdokumentation sind zu beachten.

This declaration certifies the conformity to the specified directives but does not imply any warranty for properties. The safety documentation accompanying the product shall be considered in detail.

La présente déclaration atteste de la concordance avec les directives citées, elle n'offre cependant pas de garantie quant à la nature ou la durabilité selon l'article 443 du code civil allemand. Les consignes de sécurité de la documentation du produit fournie sont à respecter.

10.2 Certificate of Compliance



Certificate of Compliance

Certificate: 70027582	Master Contract: 226676
Project: 70138021	Date Issued: 2017-07-14
Issued to: Evoqua Water Technologies GmbH Auf der Weide 10 Gunzburg, 89312 GERMANY	

The products listed below are eligible to bear the CSA Mark shown with adjacent indicators 'C' and 'US' for Canada and US or with adjacent indicator 'US' for US only or without either indicator for Canada only.



Issued by: *Jean-Philippe Laplante*
Jean-Philippe Laplante

PRODUCTS

CLASS - C363106 - ELECTRICAL MEASUREMENT AND TEST EQUIPMENT
 CLASS - C363186 - ELECTRICAL EQUIPMENT FOR MEASUREMENT USE-Certified to US Standards

Water management system, Models:

Main units: W3Ta E01 b; rated: 100-240Vac, 50/60Hz, 48W or 24Vdc, 30W /
 W3Ta E02; rated: 100-240Vac, 50/60Hz, 24W or 24Vdc, 15W;
 all models: 6A max rating including external loads supplied from the mains input circuit of the main units via cord outlets or permanently wired

Flow-through units: W3Tc D01 / W3Tc D02, supplied by the main units.
 (Where a, b & c are alphanumeric placeholders (different length; including blanks) for non-safety-critical properties and configurations like user interface design and water analysis functions)

DOD 507 Rev. 2016-02-18
Page 1



Certificate: 70027582

Master Contract: 226676

Project: 70138021

Date Issued: 2017-07-14

Notes:

1. The above models are permanently connected or non-detachable cord (model dependent) Equipment Class I, Pollution Degree 2, Overvoltage category II
2. Mode of operation: Continuous
3. Environmental Conditions: Extended: 0 to 50°C, 2000m max, maximum 80% RH non-condensing.

APPLICABLE REQUIREMENTS

- | | |
|---|--|
| CAN/CSA-C22.2 No. 61010-1-12 | - Safety Requirements for Electrical Equipment for Measurement, Control, and Laboratory Use, Part 1: General Requirements |
| UL Std. No. 61010-1 (3 rd Edition) | - Safety Requirements for Electrical Equipment for Measurement, Control, and Laboratory Use - Part 1: General Requirements |

CONDITIONS OF ACCEPTABILITY

1. The input pressure for the water management system shall be externally limited to 3 bars (300kPa).
2. The equipment shall be installed to the mains supply system using a disconnecting device with the off-position clearly marked and a 6A back-up fuse must be used in the main supply line (for permanently connected only)
3. Relay connections to external devices shall be connected using 5A fuses as overcurrent protection (model E01 only)
4. This product has not been evaluated for rigid conduit installation. The product shall not be installed using conduits.
5. Equipment is only to be installed by authorized qualified electricians.
6. Maintenance of equipment (including fuse and battery replacements) is only to be performed by authorized qualified electricians.
7. Equipment is not to be used with flammable liquids.



Supplement to Certificate of Compliance

Certificate: 70027582

Master Contract: 226676

The products listed, including the latest revision described below, are eligible to be marked in accordance with the referenced Certificate.

Product Certification History

Project	Date	Description
70138021	2017-07-14	CSA c/us report update for alternate construction (new models E02 & D02) on a Water management system, Models: W3Ta E01 b, W3Ta E02 with flow-through modules: W3Tc D01 / W3Tc D02
70095602	2016-10-19	CSA c/us report update for alternate construction (relay) and model naming changed on a Water management system, Models: W3Txxxxxx-E01 / W3Txxxxxx-D01
70027582	2015-07-09	CSA (c/us) certification of a pool management system for water treatment based on the acceptance of CB test report.

11.Index

A

Actuator feedback 35
Adaption 37

- Completing with errors 39
- Completing without errors 39
- Error message 38
- Errors 40
- Requirements 37
- Sequence 38
- Start 38

Analog inputs 104
Analog output controller 2-point

- Function 21

Analog output controller 3-point

- Function 21

B

Battery, replacing 139
Buttons

- Explanation 77

C

Calibration 123

- Chlorine 124
- Conductivity 130
- ORP (mV) 129
- pH 127
- Sensor measuring module 123
- Temperature 123

CAN connection 48
CEDOX

- Calibration 29
- Commissioning 29
- Control system 28
- Operating mode 28

Cleaning 140
Color signals 122
Control 84
Control direction 25
Control elements 75
Control parameter 22
Controller

2-point pulse duration controller 20
2-point pulse frequency controller 20
3-point pulse duration controller 20
Controller modes

- CEDOX 31
- CEDOX control 27
- CEDOX control system 28
- Cl₂ + ECO-CEDOX 32
- Cl₂ single feedback 30
- Cl₂ single feedback closed loop control 27
- Combinations 30
 - for chlorine control 27

Controller outputs 19
Controller setting

- "Cl₂ free" 86
- Cl total 87
- Conductivity 87
- pH 87

Controller Stop

- Function 22

Controllers with mA output

- Function 20

Conventions 6

D

Data formats 53
Data type

- ASCII 54
- FLOAT 54
- INT16 / UINT16 53
- INT32 / UINT32 53
- INT8 / UINT8 53

Diagnosis 120
Diagnosis Menu Module 120
Digital inputs 35
DIN/ECO contact 41
DIN/ECO functions 97
Display

- LED 114

Display elements 75
Documentation 5
Dosing

- CI2 free 91
- CI-N 92
- Conductivity 92
- pH 91
- Dosing contact
 - Function 21
- E
- ECO mode 42
- Electrical Installation 65
- Electronics module
 - Design 17
 - General 15
- Error messages 131
 - can be acknowledged 131
 - cannot be acknowledged 132
- Errors 136
- Ethernet interface 50
- Explanation
 - Buttons 77
- Export archive data 118
- F
- Faults 131
 - Error messages 131
 - Errors 136
- Fieldbus converter 50
- First commissioning 71
- Flocculation control 40
- Function 18
 - DIN/ECO 97
- Functions
 - Actuator feedback 35
 - Examples of applications 18
 - Process measurements 18
- G
- General
 - Blu-Sentinel™ Pro electronics module 15
- I
- Inputs / outputs 98
- Installation 59
 - 4-way relay board 142
 - Electrical 65
 - Fieldbus converter 143
 - mechanical 61
 - with din rail 62
 - without din rail 63
- Installation site 60
- Installing 142
- Intended use 9
- Interface 47
 - CAN connection 47
 - CAN connector 47
 - CAN interface 47
 - Ethernet interface 50
 - Fieldbus converter 50
 - Modbus TCP interface 52
 - RS485 interface 49
 - USB interface 50
- Interfaces 35
- IT security 10
- L
- LED Display 114
- LED glow stick 105
- Limit contacts 33
 - acknowledgment 34
 - Acknowledgment with reset 34
 - Latched with acknowledgement 34
 - Latched with reset acknowledgment option 34
 - Unlatched without acknowledgment option 33
 - without acknowledgment 33
- M
- Maintenance 137
- Maintenance intervals 137
- Max. pulses/min 22
- Measurement
 - CI2 free 81
 - CI2 total 81
 - Conductivity 82
 - ORP 81
 - pH 81
- Measurements 79
- Mechanical installation 61
- Menu
 - Adaption 93
 - Analog outputs 103
 - CI2 free - measurement 79, 84
 - Digital inputs 102
 - DIN contact 100
 - Dosing output 101
 - Dosing parameter 101
 - ECO mode 95
 - Flocculation 101
- Menü
 - Peak chlorination 94
- Menu field

- Calibration 82
- Control 85
- Functions 93
- Measurement range 80
- Message system 121
- Operation mode 106
- Password 107
- Sensor 80, 85
- Set time/date 106
- Settings 109
- Trend analysis 83
- Trend diagram 82
- Modbus TCP 50

- O
- Operating mode 78
- Operation 75
 - Cl₂ free - measurement 79, 84
 - Control 84
 - Diagnosis 120
 - Display and control element 75
 - Operating mode 78
 - System 105

- P
- Password 77
 - Level 107
 - VNC viewer 50
- Peak chlorination 43
- Positioner
 - Function 20
- Profibus DP 50

- R
- Reference list 54
- Relay outputs 36
- Replacing the fuse 138
- Retrofit kits 141
- RS485 interface 49

- S
- Safety
 - Personnel 10
 - Safety functions 43
 - Scope of supply 59
 - Setpoint 22
 - Settings
 - Display 110
 - Ethernet 111
 - Factory setting 110
 - Parameter Transfer 112
 - RS485 interface 113
 - Setup 115
 - System 115
 - Shut down 74
 - Spare parts 143
 - Storage 60
 - System 105

- T
- Tn 23
- Tp 23
- Transport 60
- Ts 24
- Tu 24
- Ty 24

- V
- Version 16
- VNC viewer
 - password 50

- W
- Warranty 12

- X
- Xp 25
- Xsh 25

- Y
- Ymax 26
- Ymin 26





6 Jefferson Drive, Coventry RI 02816

+1(800) 832-8002 (toll-free) +1 (401) 821-2200 (Toll) www.evoqua.com

DEPOLOX, OSEC, Barrier, Chem-Ad, Blu-Sentinel, Wallace & Tiernan and Neptune-Benson are trademarks of Evoqua, its subsidiaries or affiliates, in some countries.

All rights, especially those to duplication and distribution as well as translation, are reserved. No part of this document may be reproduced in any form (printing, photocopying, microfilm or any other method) or saved, processed, duplicated or distributed by the use of electronic systems without the express written consent of Evoqua Water Technologies GmbH.

All information presented herein is believed reliable and in accordance with accepted engineering practices. Evoqua makes no warranties as to the completeness of this information. Users are responsible for evaluating individual product suitability for specific applications. Evoqua assumes no liability whatsoever for any special, indirect or consequential damages arising from the sale, resale or misuse of its products.

© 2018 Evoqua Water Technologies GmbH Subject to change without notice WT.050.811.110.DE.IM.0718
W3T386191 Issue 05-0718